

# 製漿造紙廠作業

彭元興

大葉大學環工系

2006年9月16日

# 影響造紙廠營運的參數

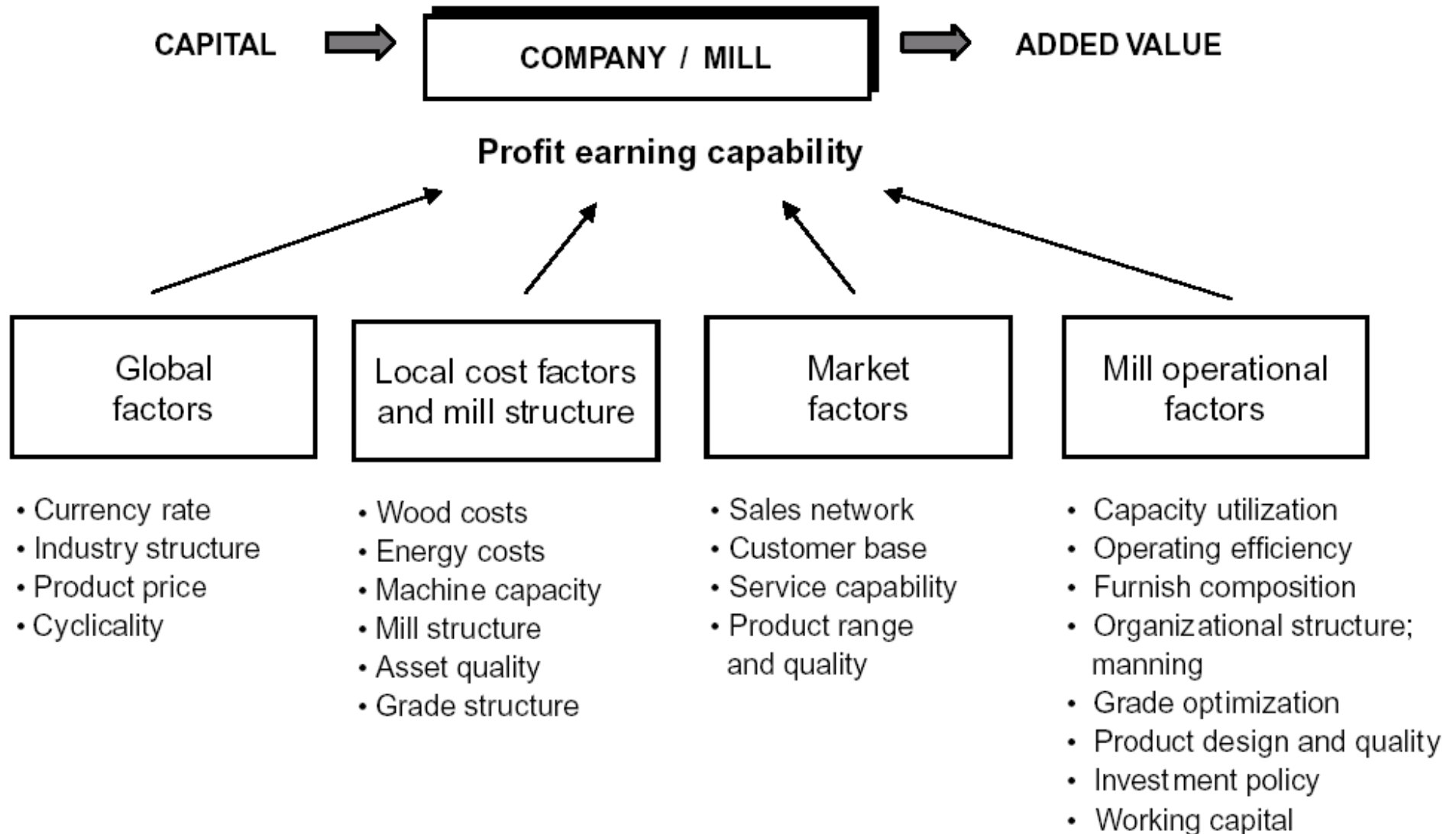

# 製漿造紙廠範圍

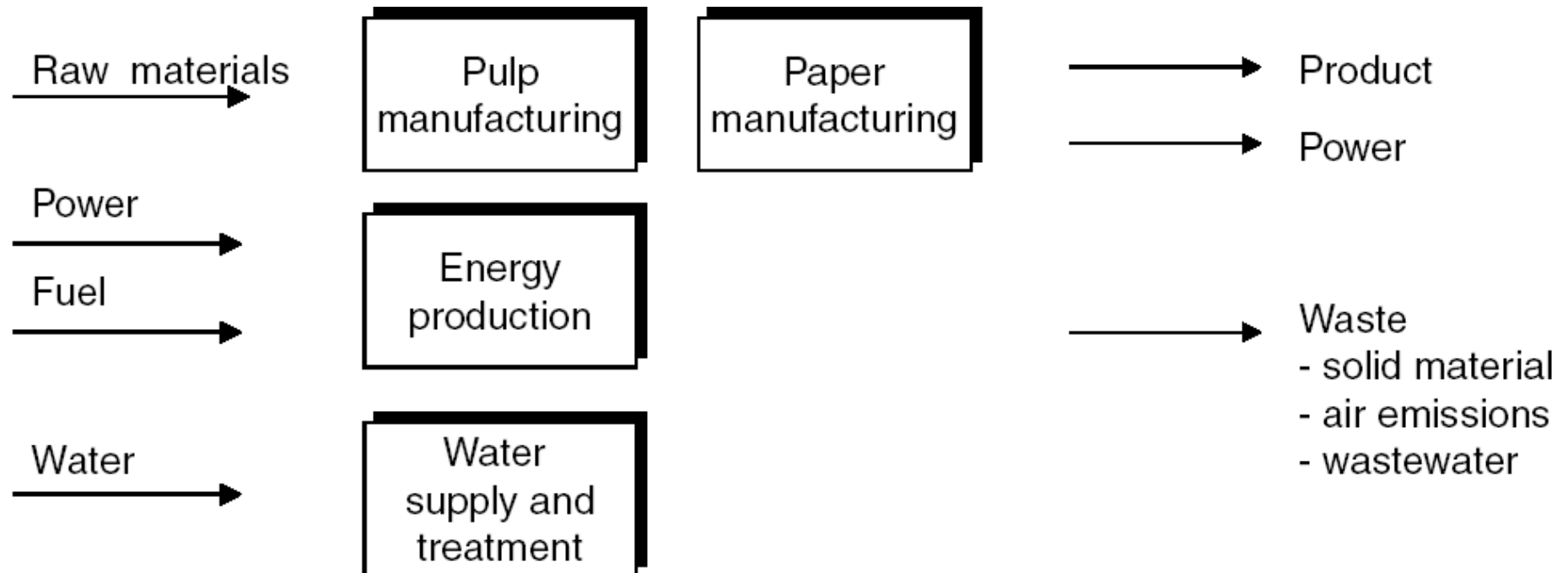

# 製漿造紙廠組織層系

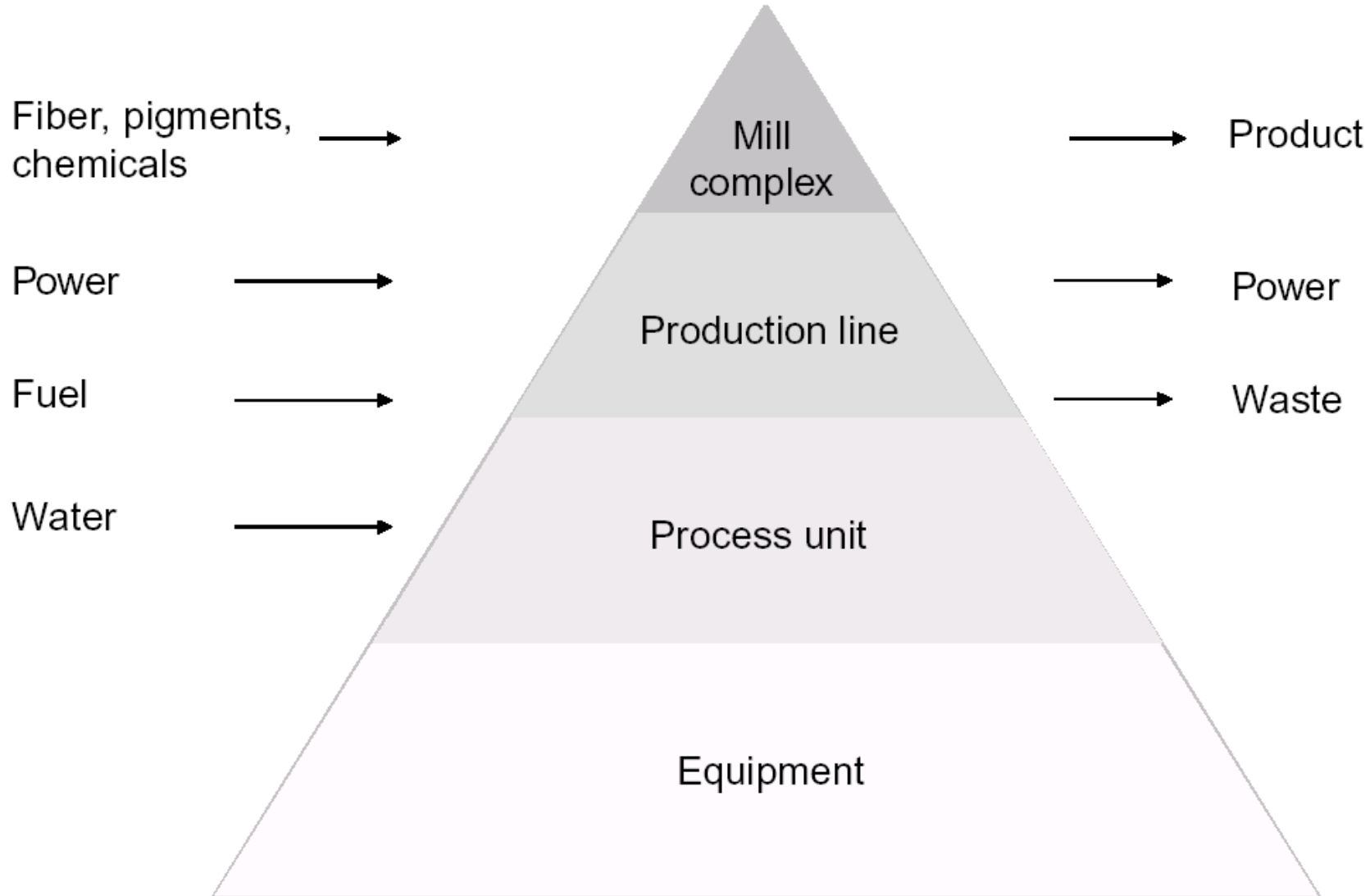

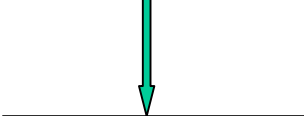

漿料備製

漿料備製系統設計實務

濕端化學

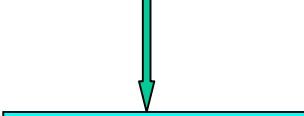

抄網及噴淋管設計與應用

功能性化學品

濕端操作

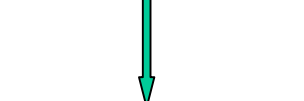

抄紙機系統設計實務

流程化學品

乾端操作

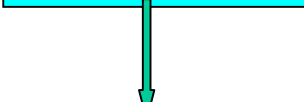

輥與包膠

白水系統

澱粉及特用化學品

塗佈作業

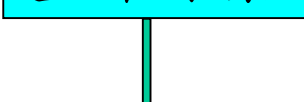

毛毯與帆布

無機填料及塗料

整理作業

塗佈概論

塗佈實務

紙張染色/增白及塗料調色

# 製漿造紙廠(含塗佈)

PGW; GW

TMP

DIP

PM

Chemical  
pulp  
handling

Coating

Pigment  
handling

Finishing

# 製漿造紙廠流程圖

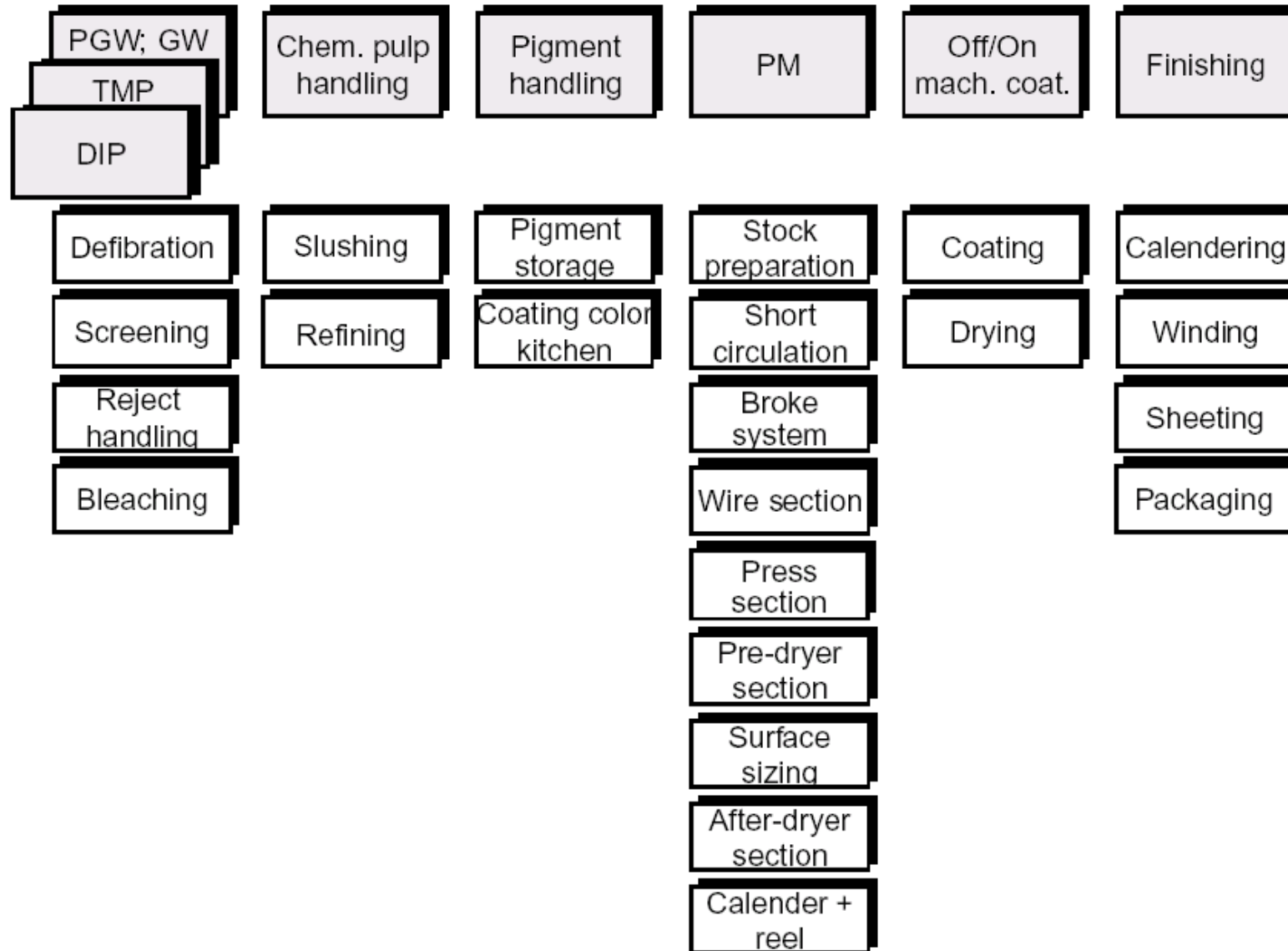

# WOOD CHIP HANDLING LAYOUT

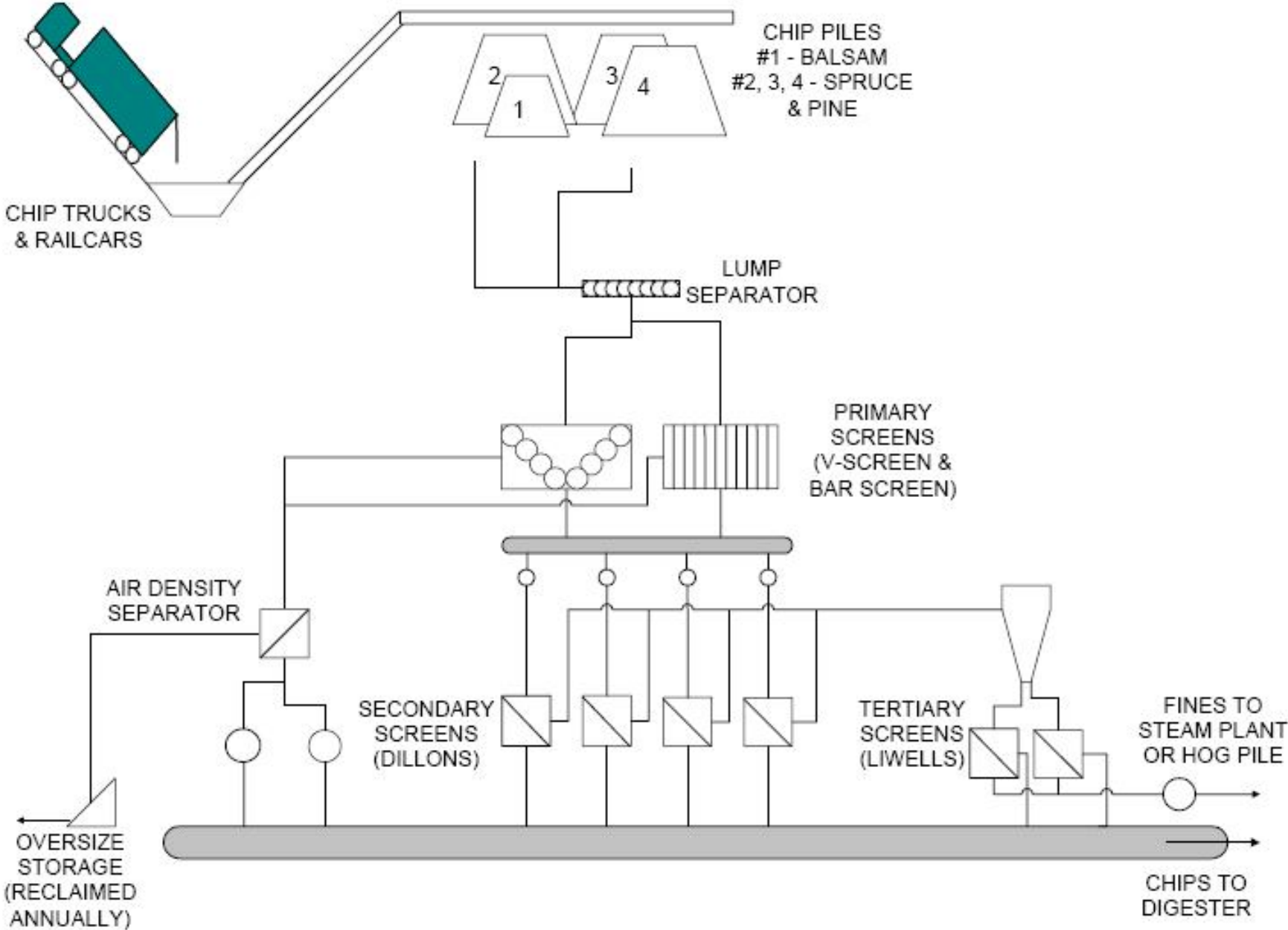



# KRAFT PROCESS LAYOUT

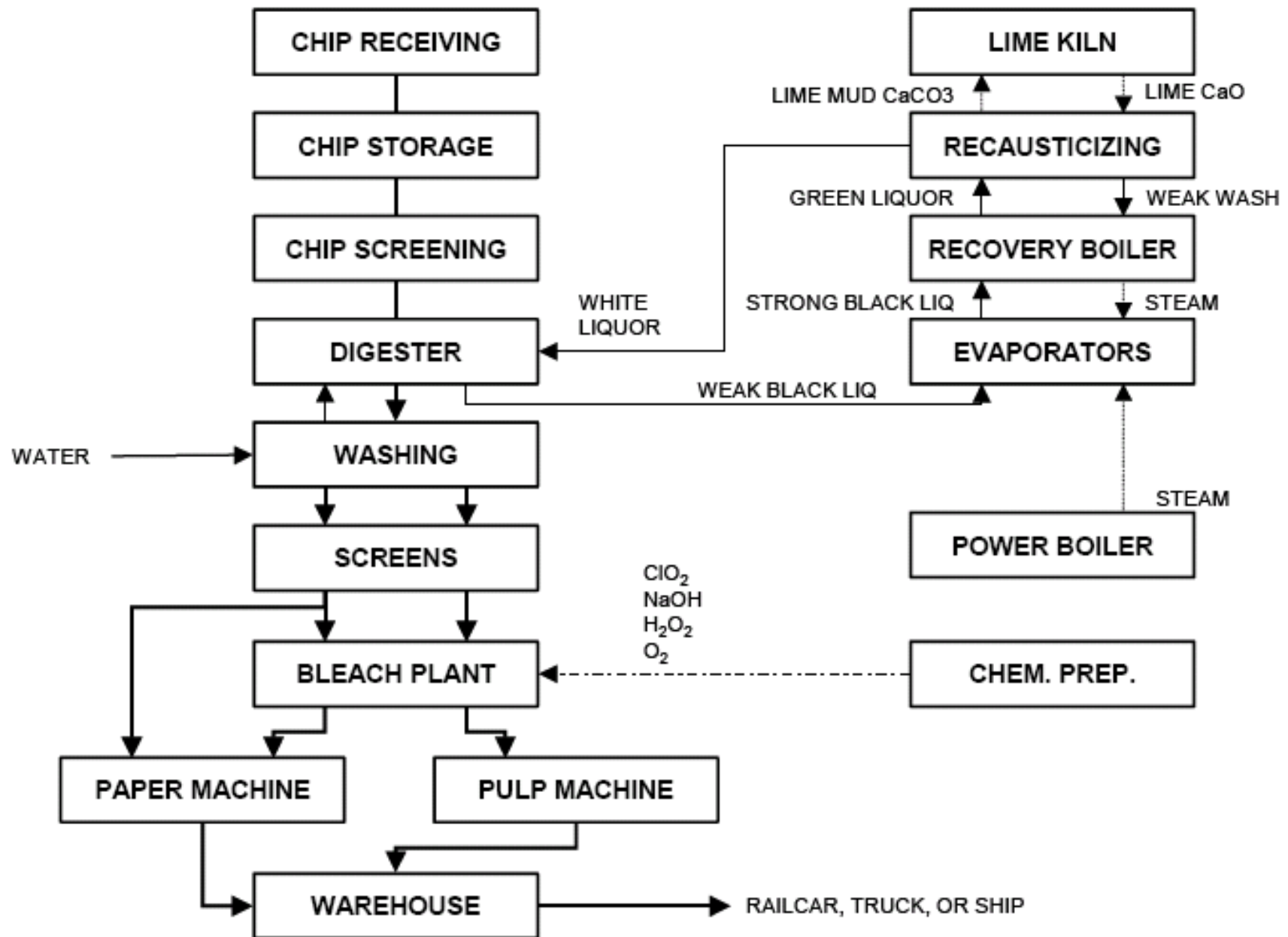

# COOKING AND WASHING LAYOUT

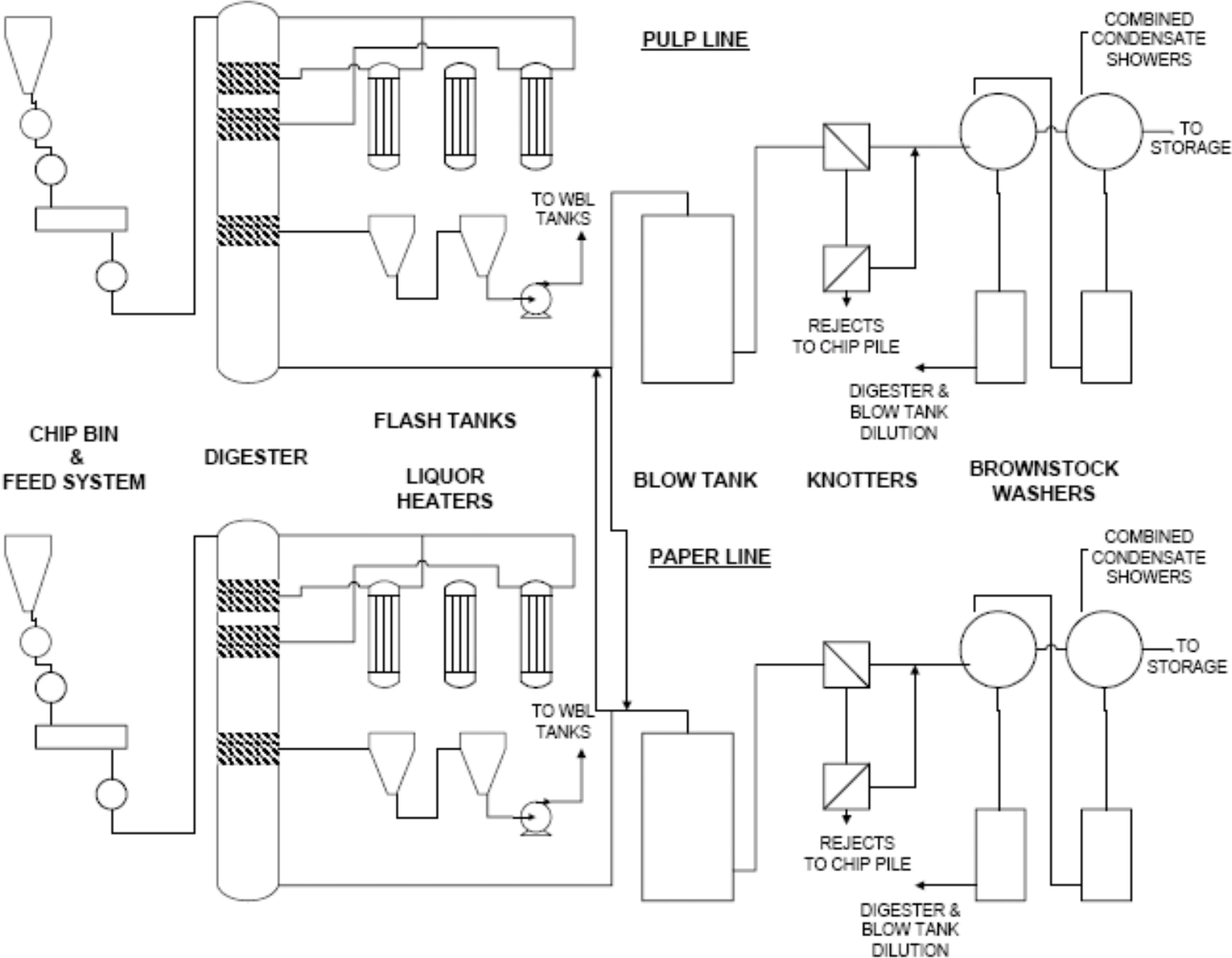

# BROWNSTOCK SCREENING LAYOUT

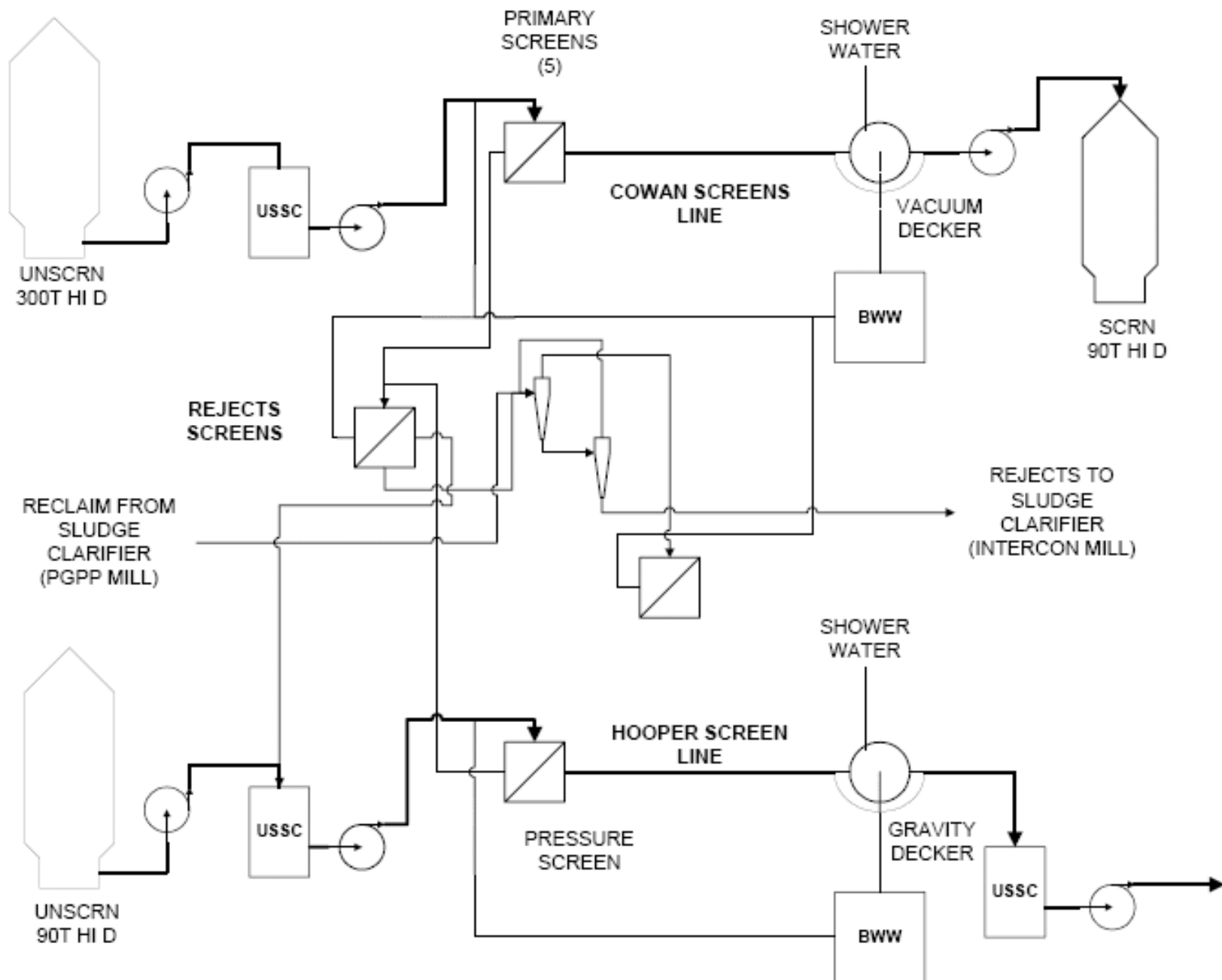

# BLEACH PLANT LAYOUT

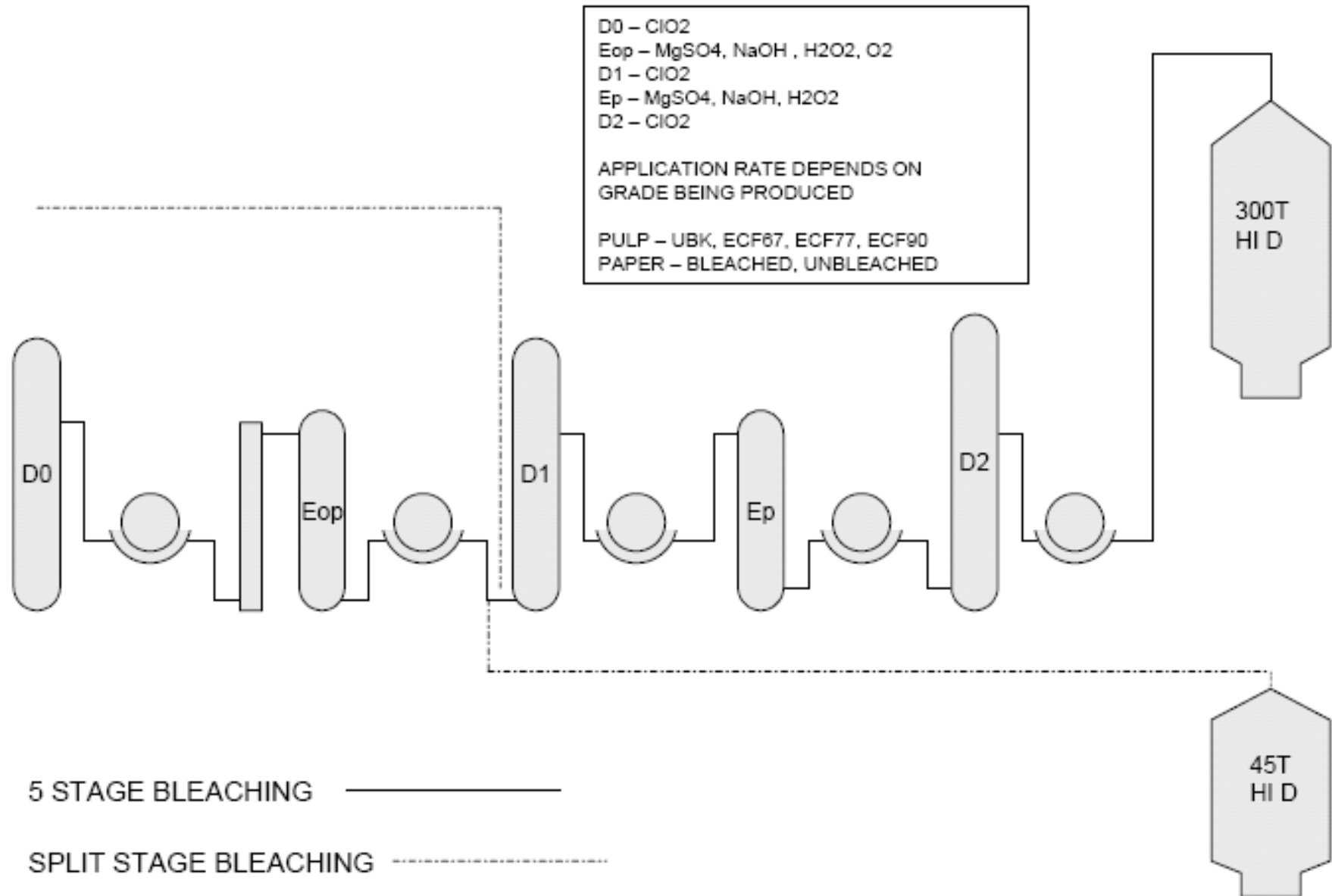

# PULP MACHINE LAYOUT

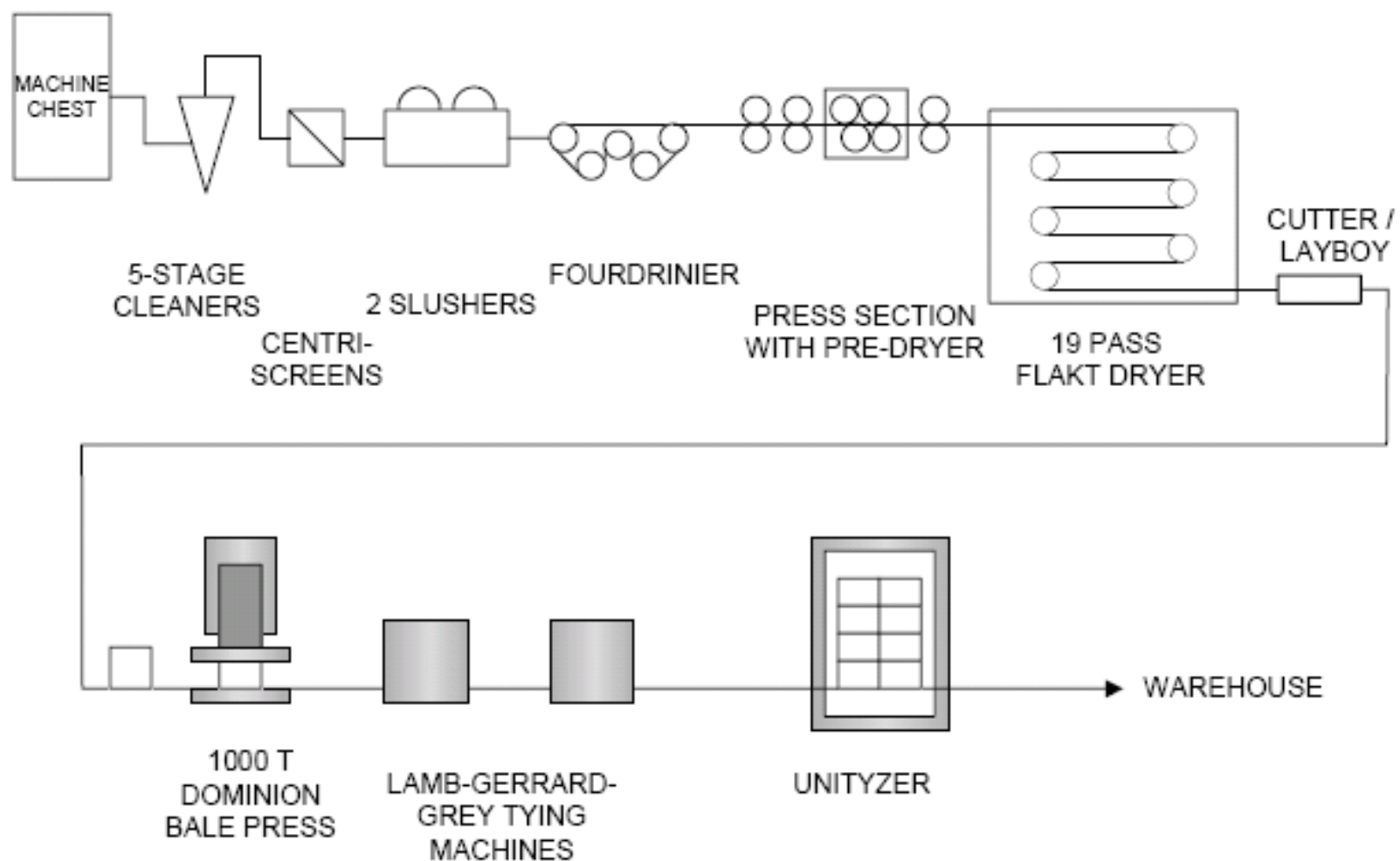

# PAPER MACHINE LAYOUT

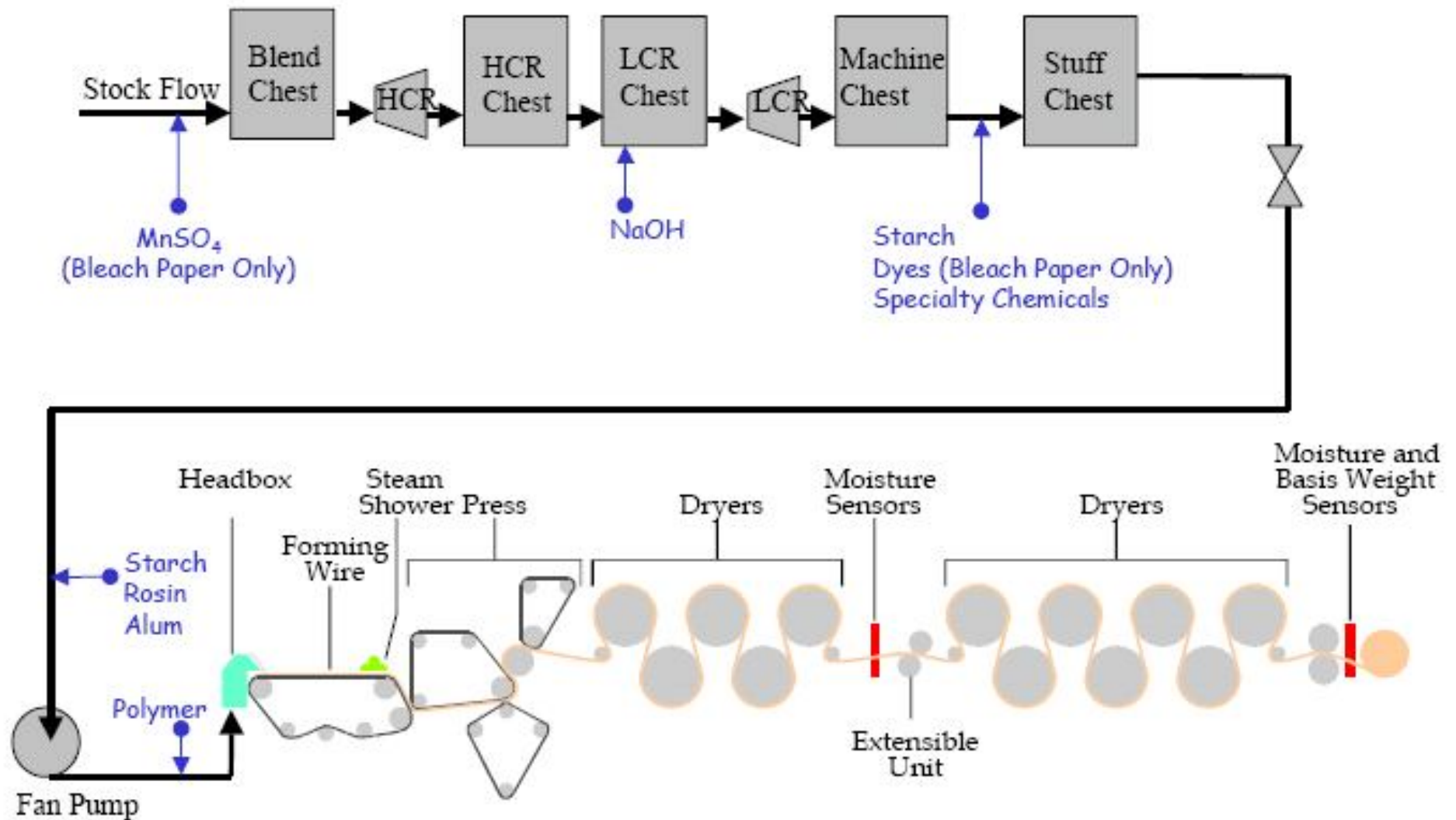

# STEAM PLANT LAYOUT

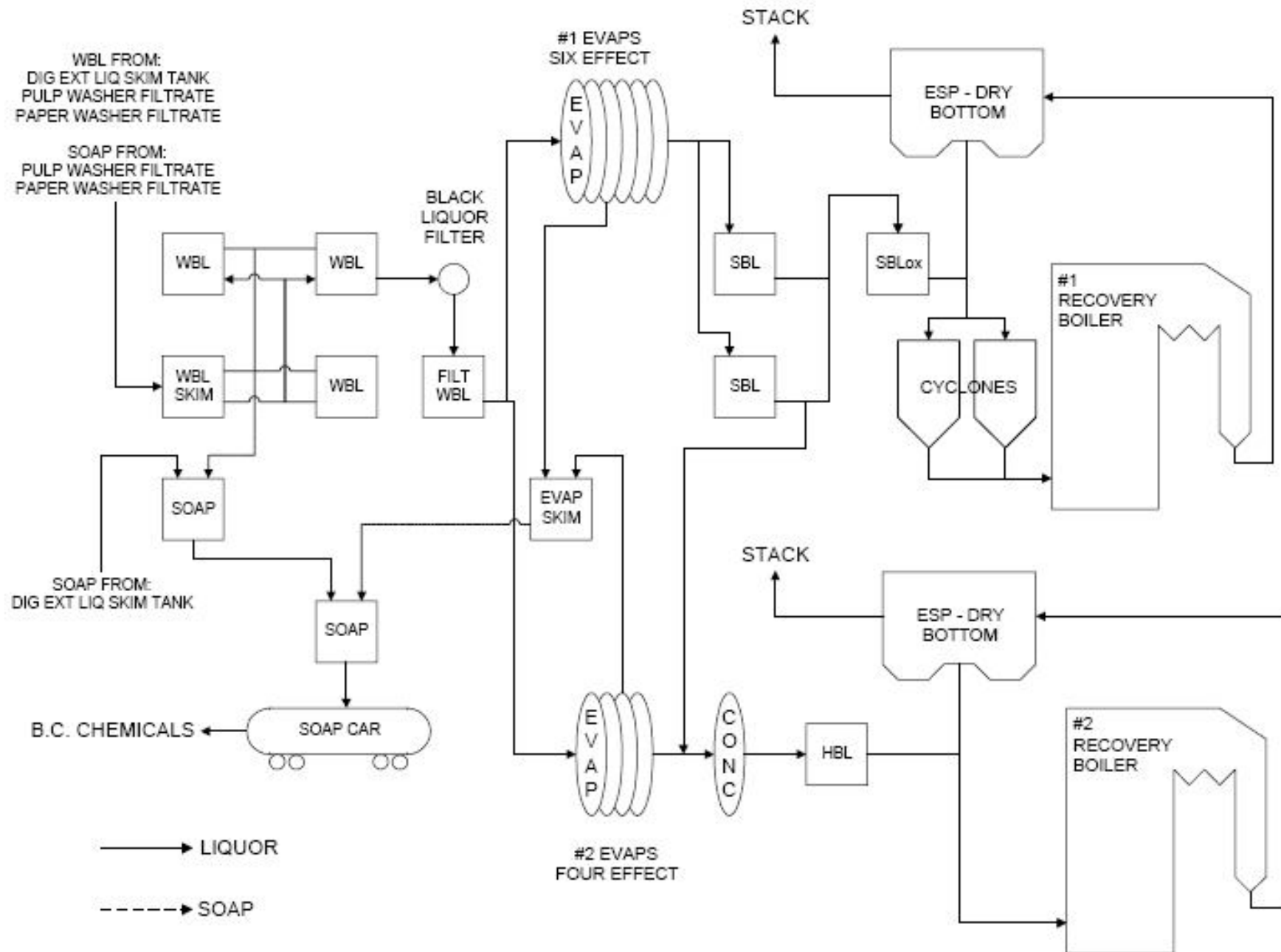

# LIME KILN & RECAUSTICIZING LAYOUT

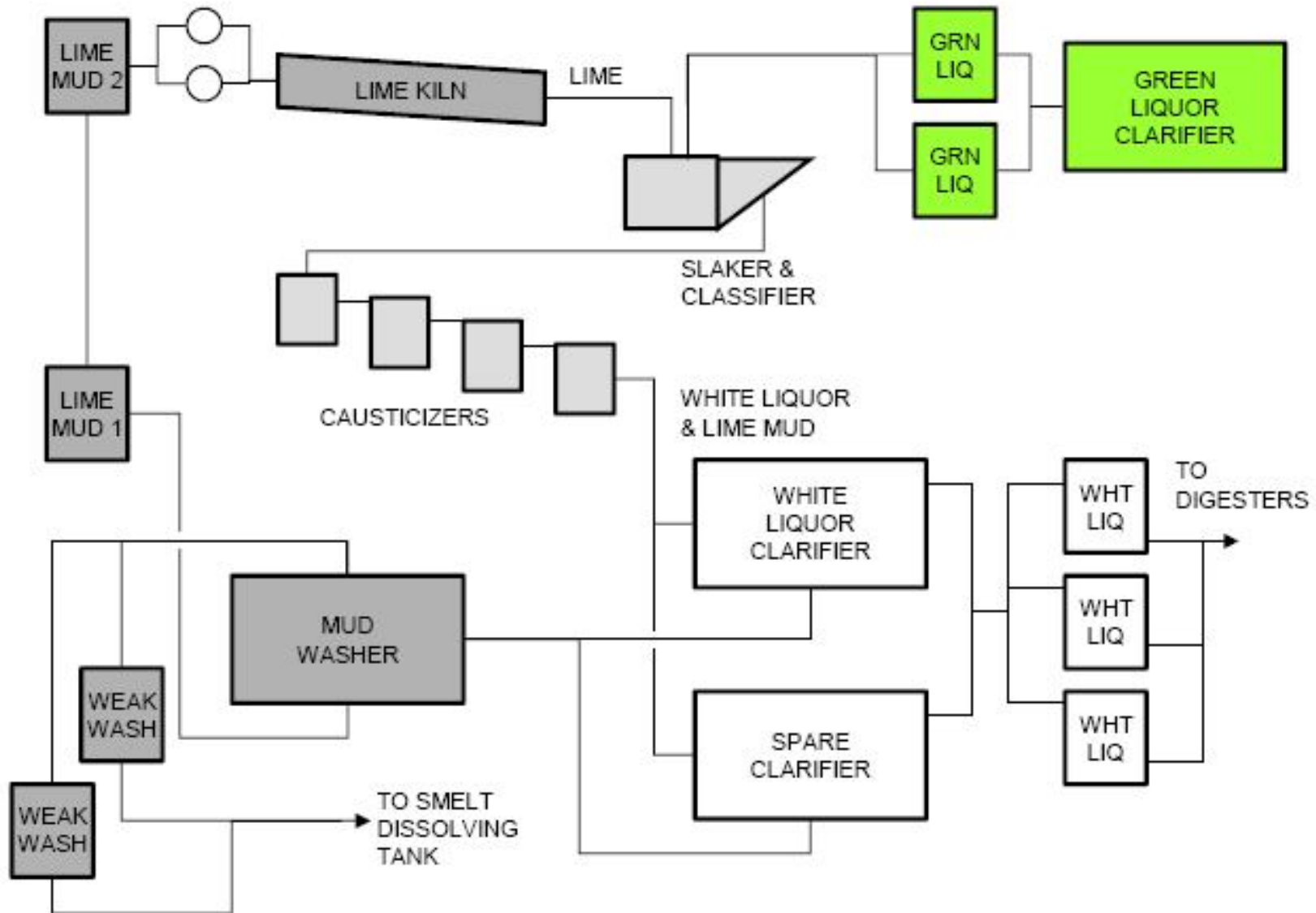



# EFFLUENT TREATMENT LAYOUT

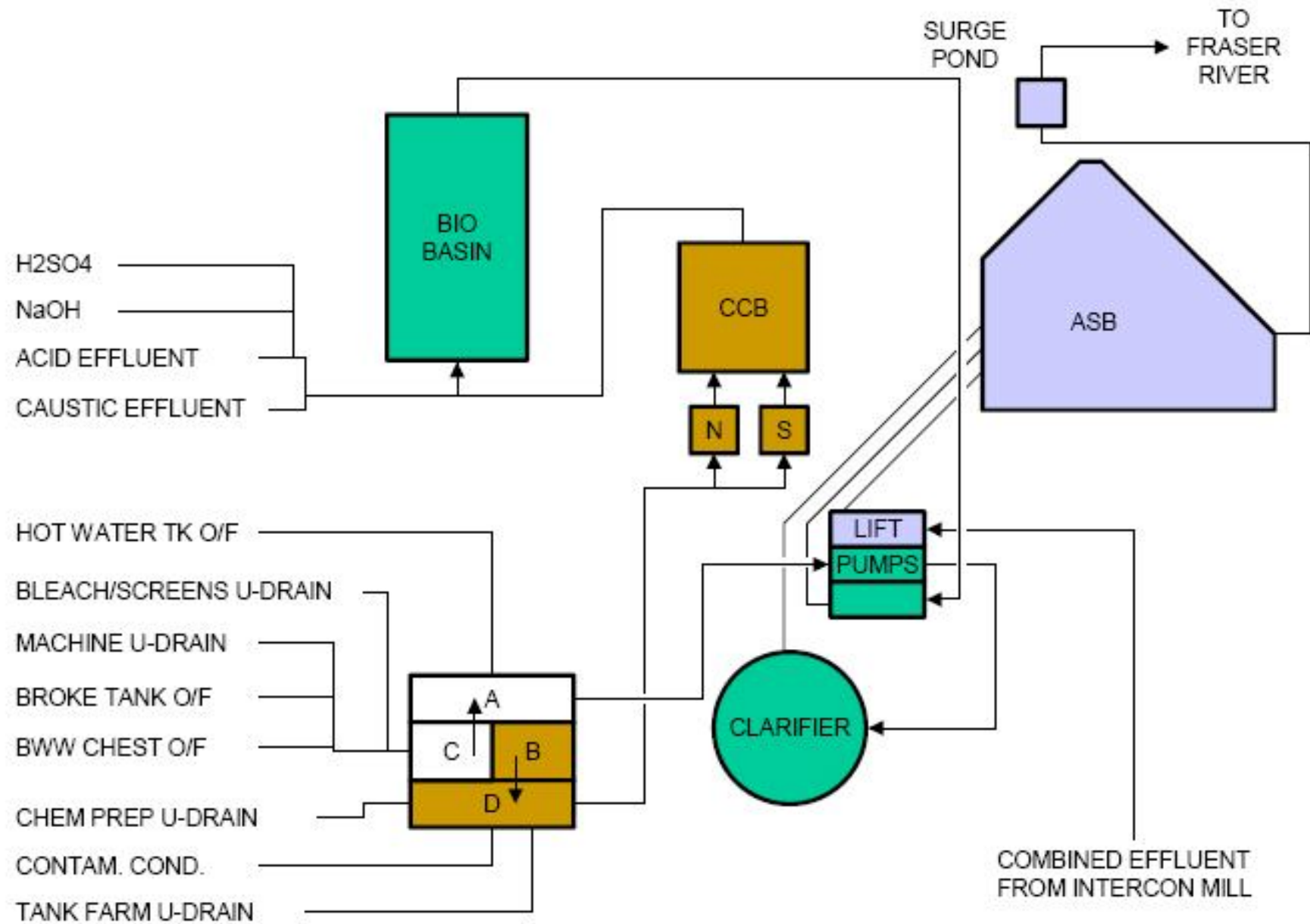

# Unit Processes in Stock Preparation

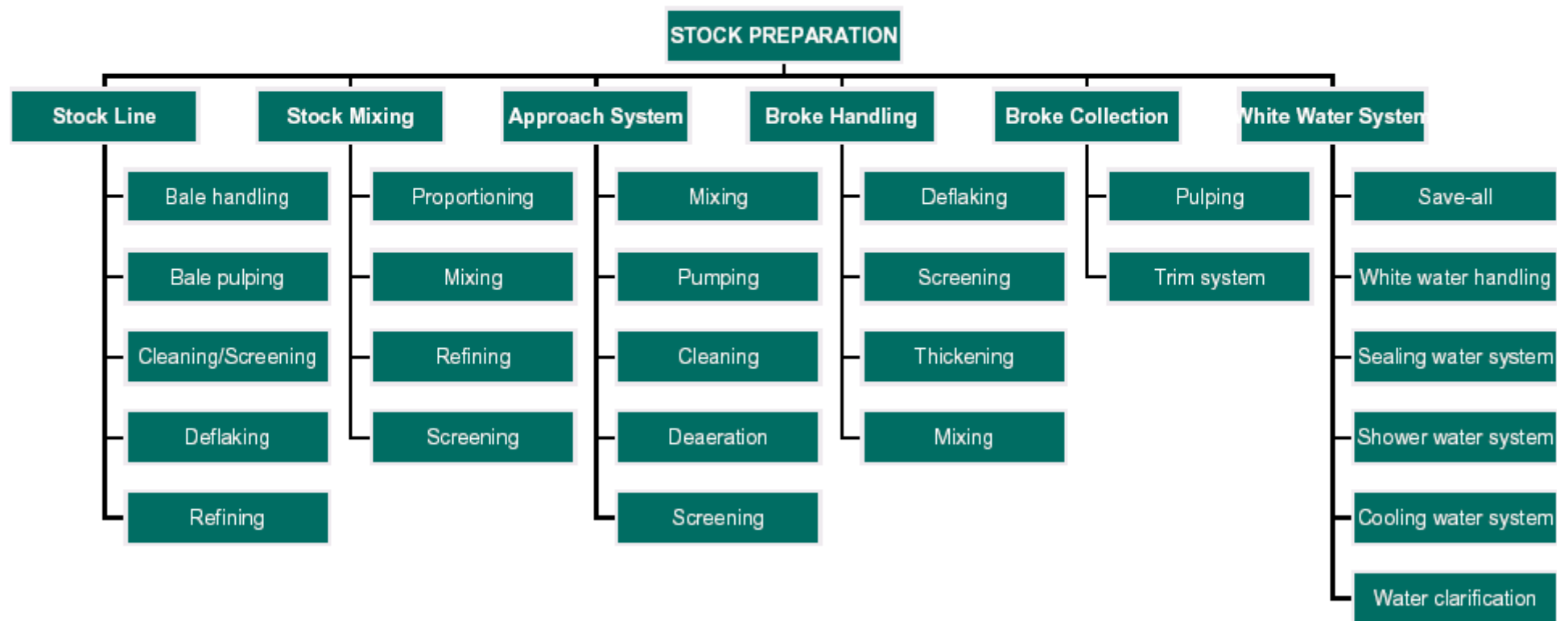

# Stock Line

Complete Stock Line for bleached sulphate pulp bales with batch pulper and refining

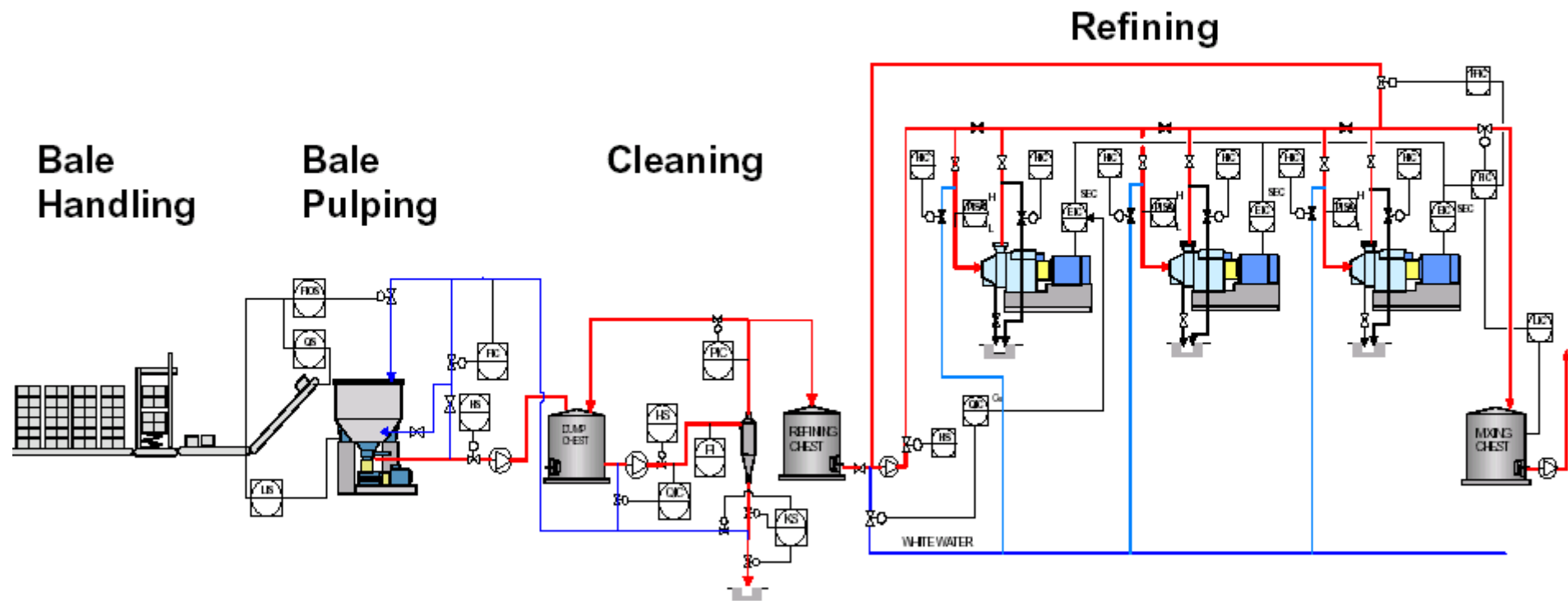

# Approach System

Typical approach system for modern paper machine

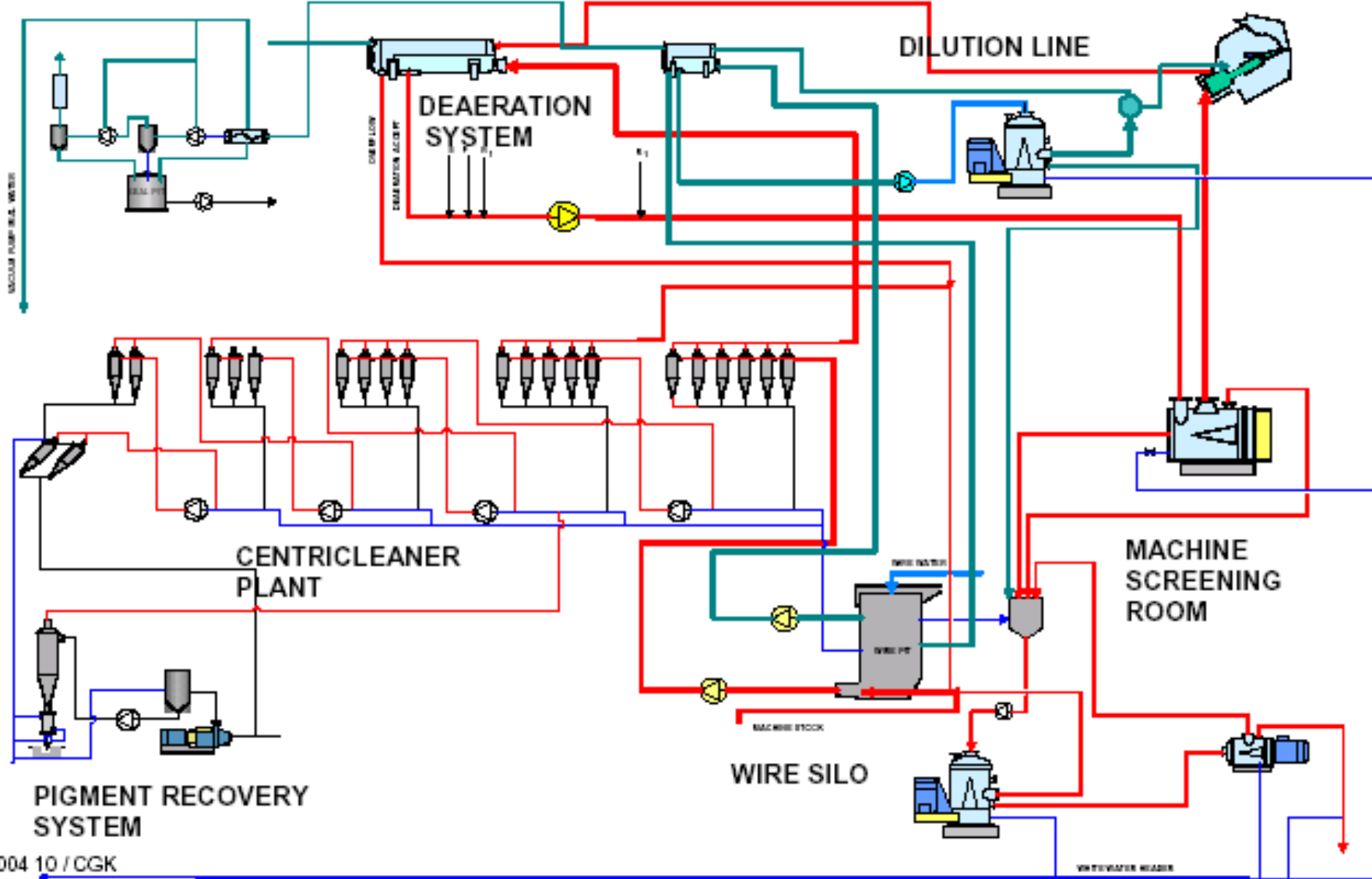

# Broke Collection

Typical broke collection & handling for specialty paper

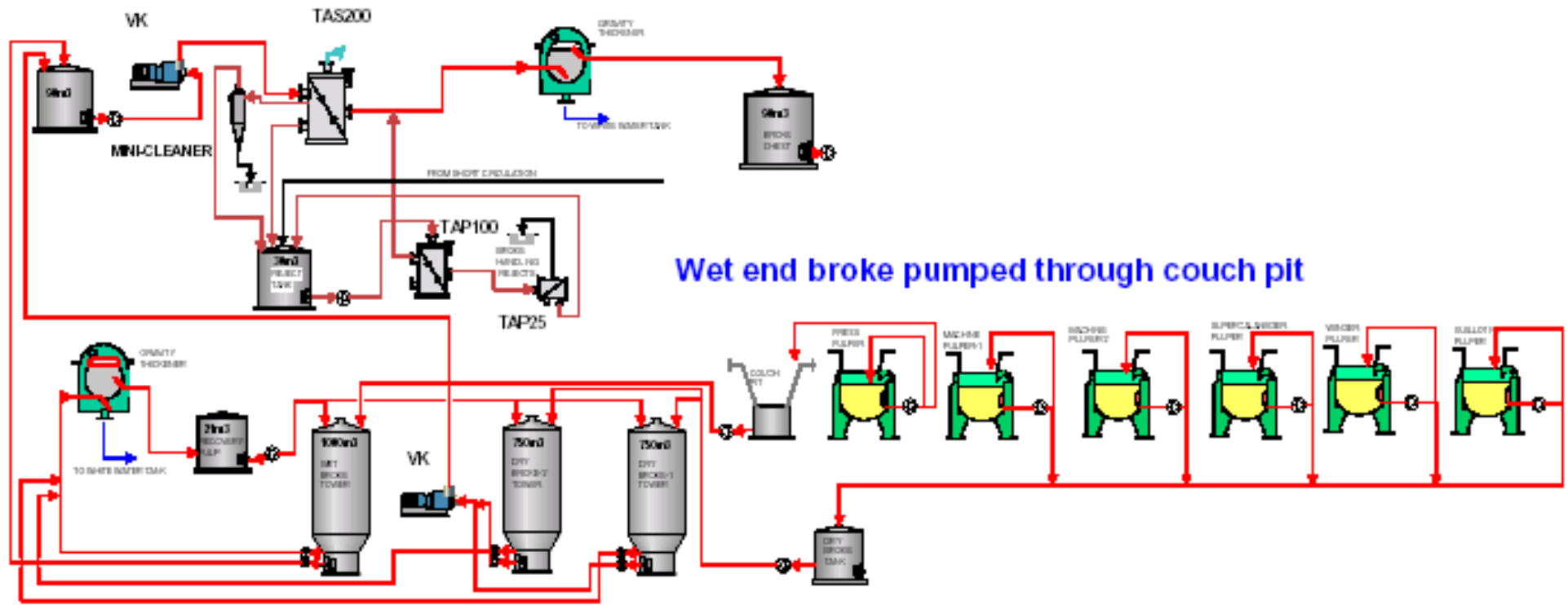

Wet end broke pumped through couch pit

Dry end broke pumped from chest

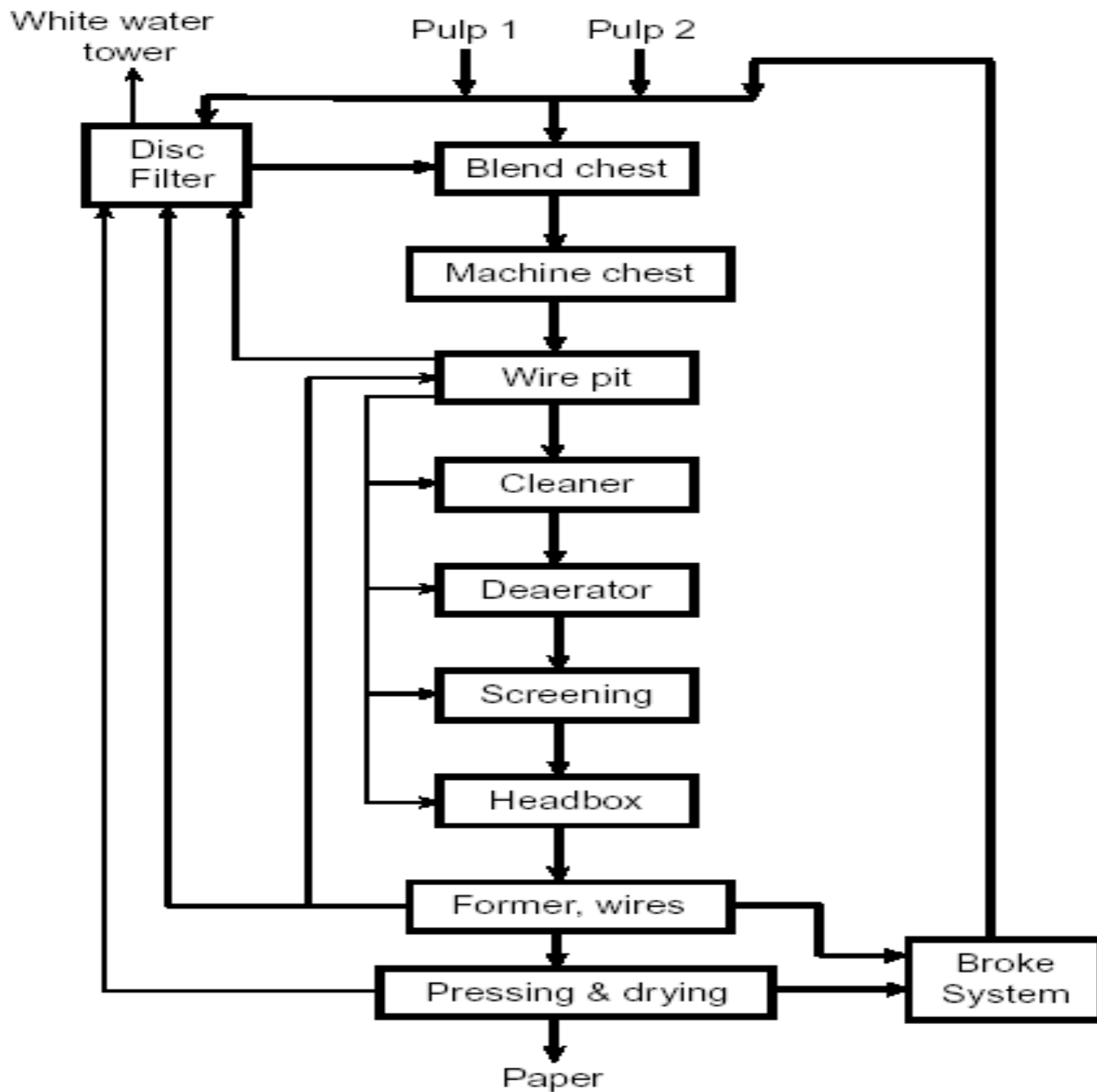

# Coated Fine Paper

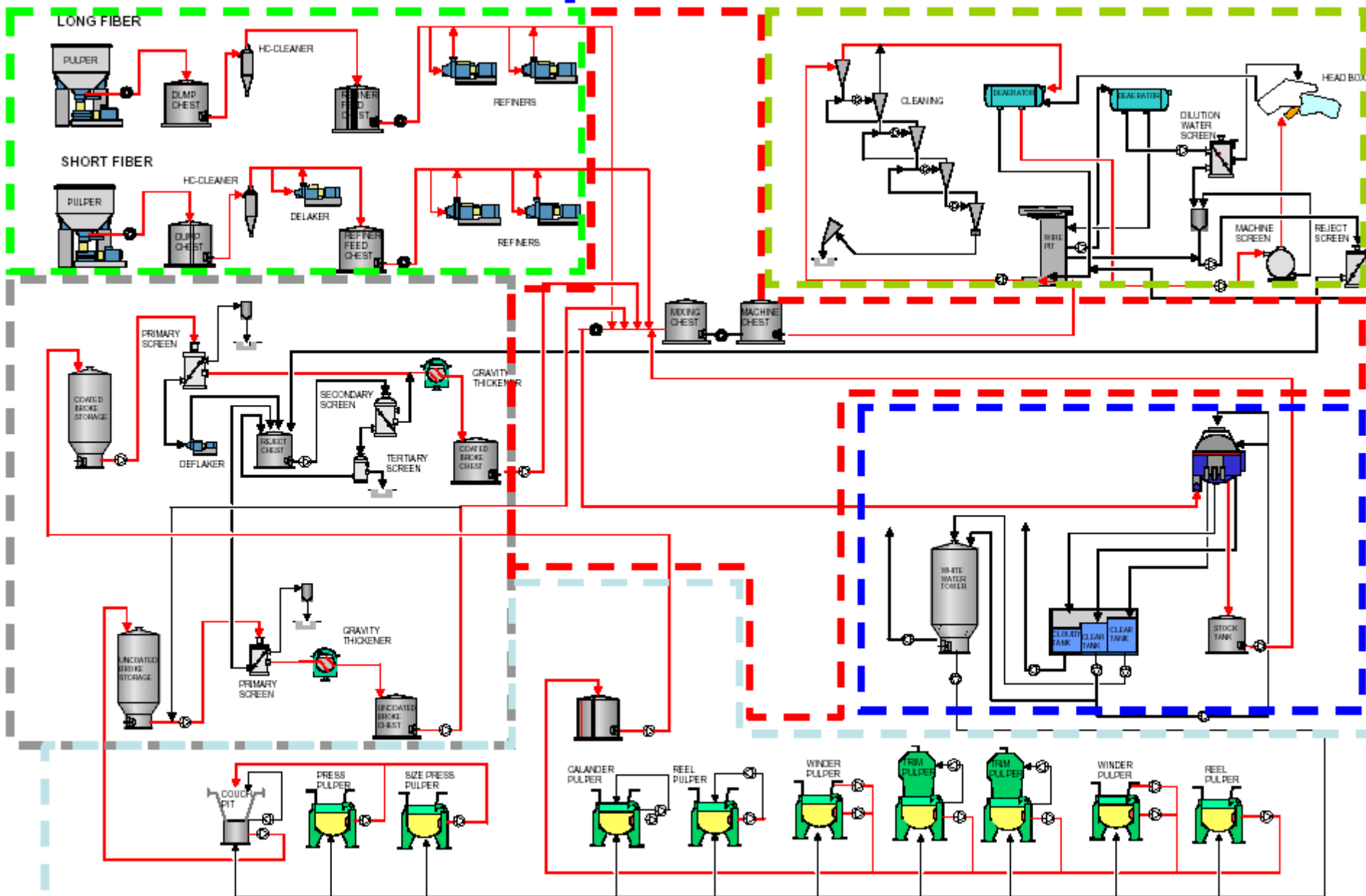

# 典型LWC抄紙機示意圖

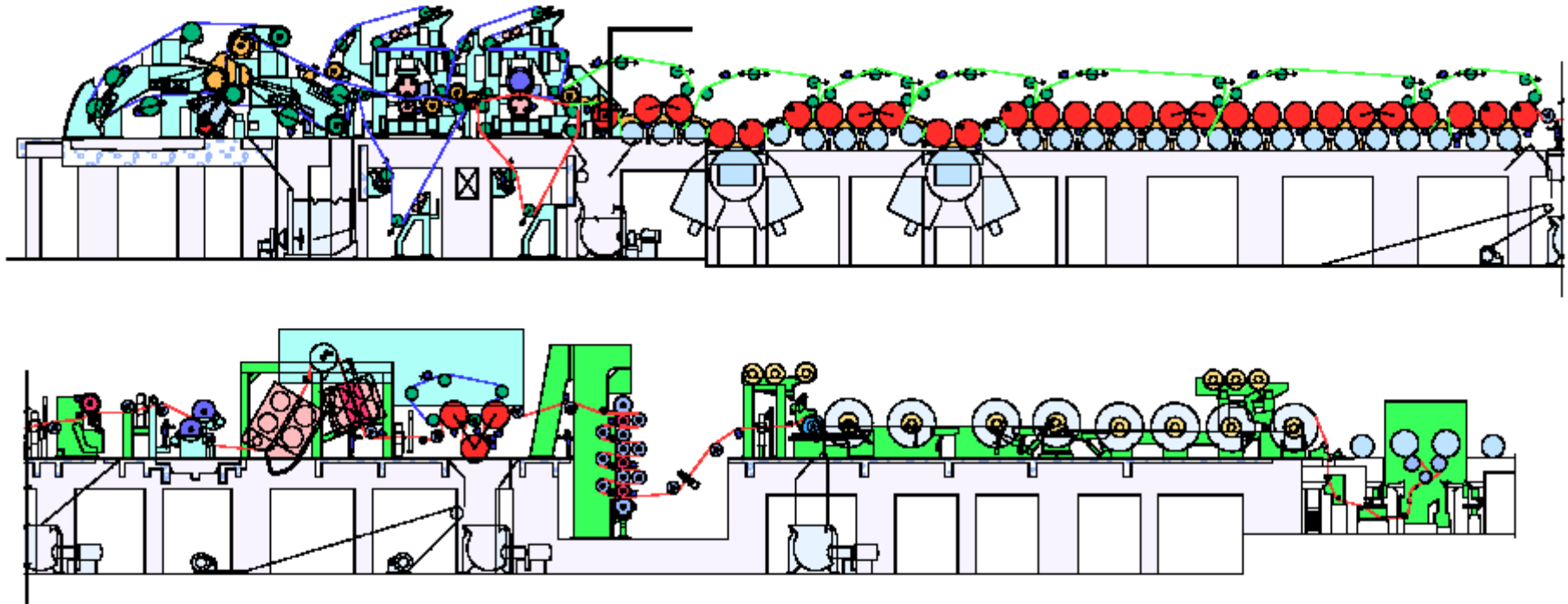



# 製漿造紙廠能源供應系統

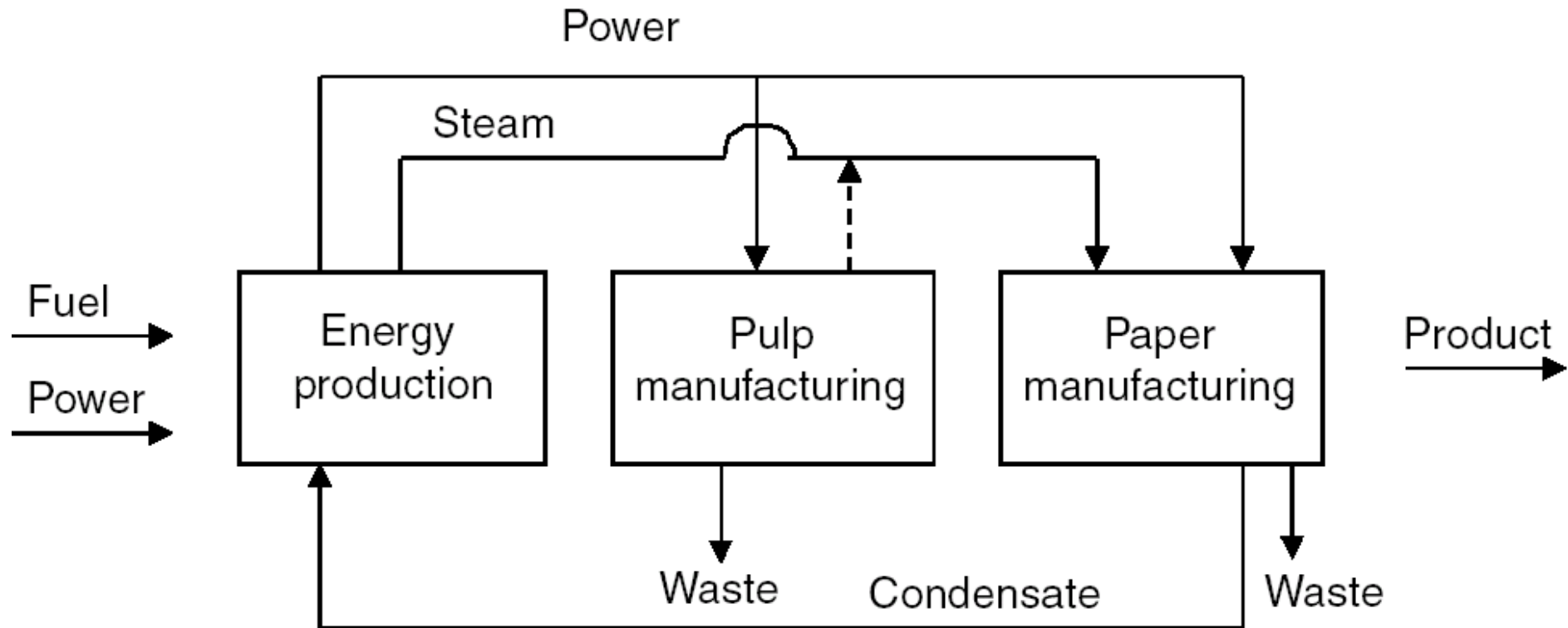

# 製漿造紙廠水系統圖

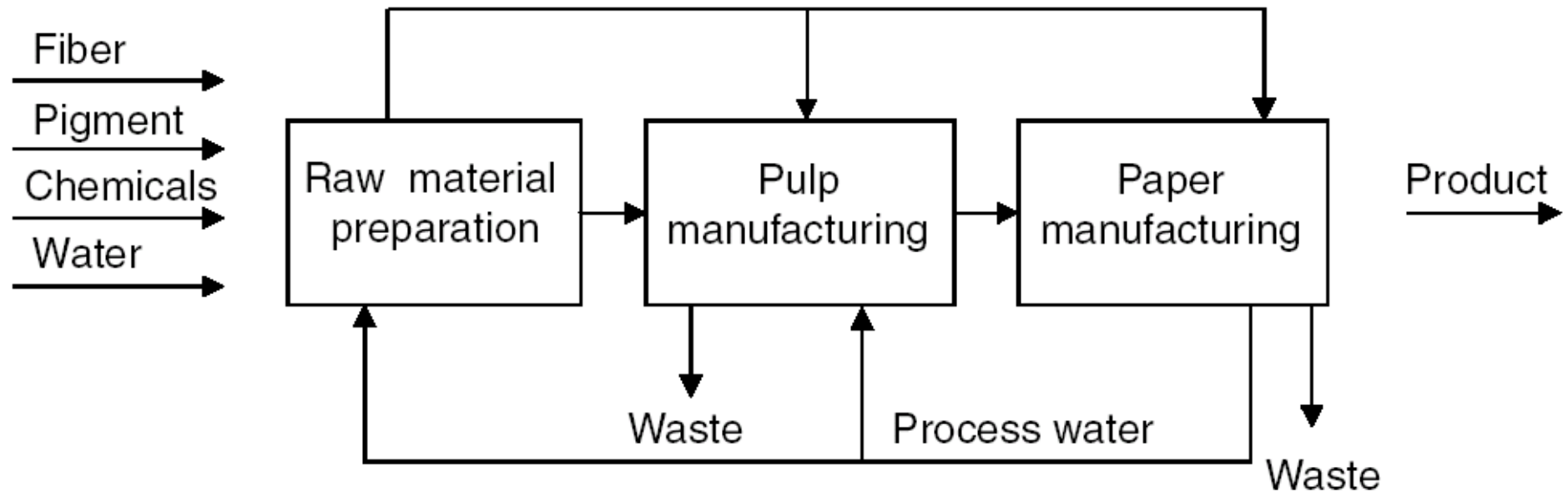

# 製漿造紙廠組織圖

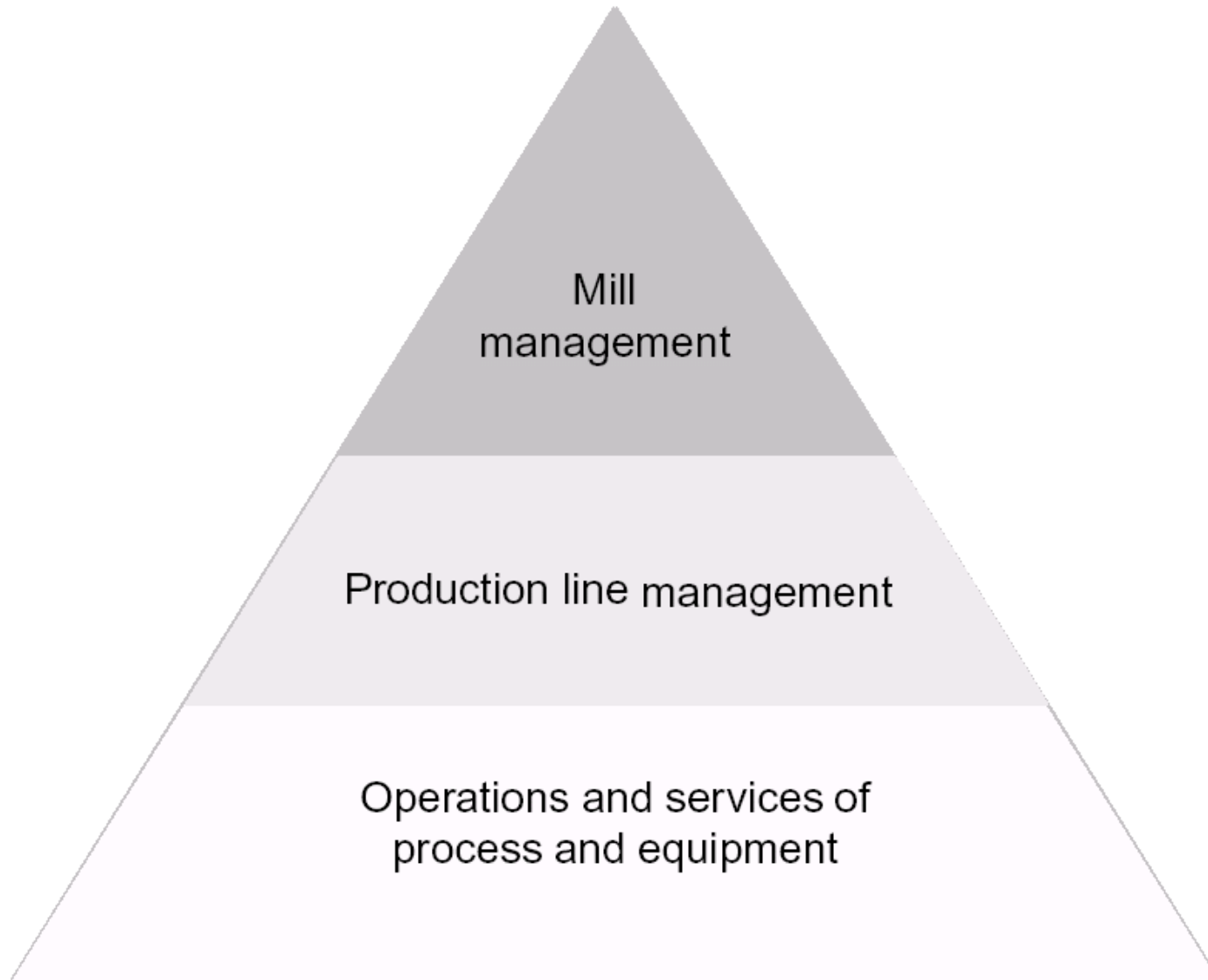

# 新聞紙廠

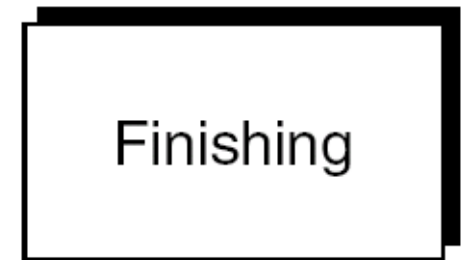
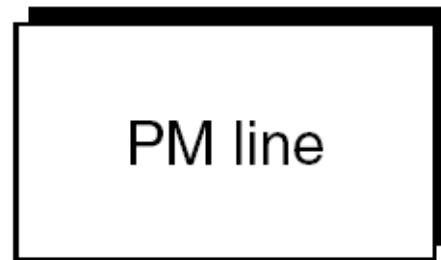
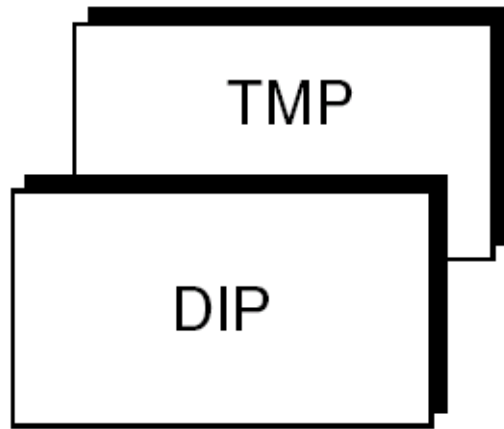

# 新聞紙TMP線方塊圖

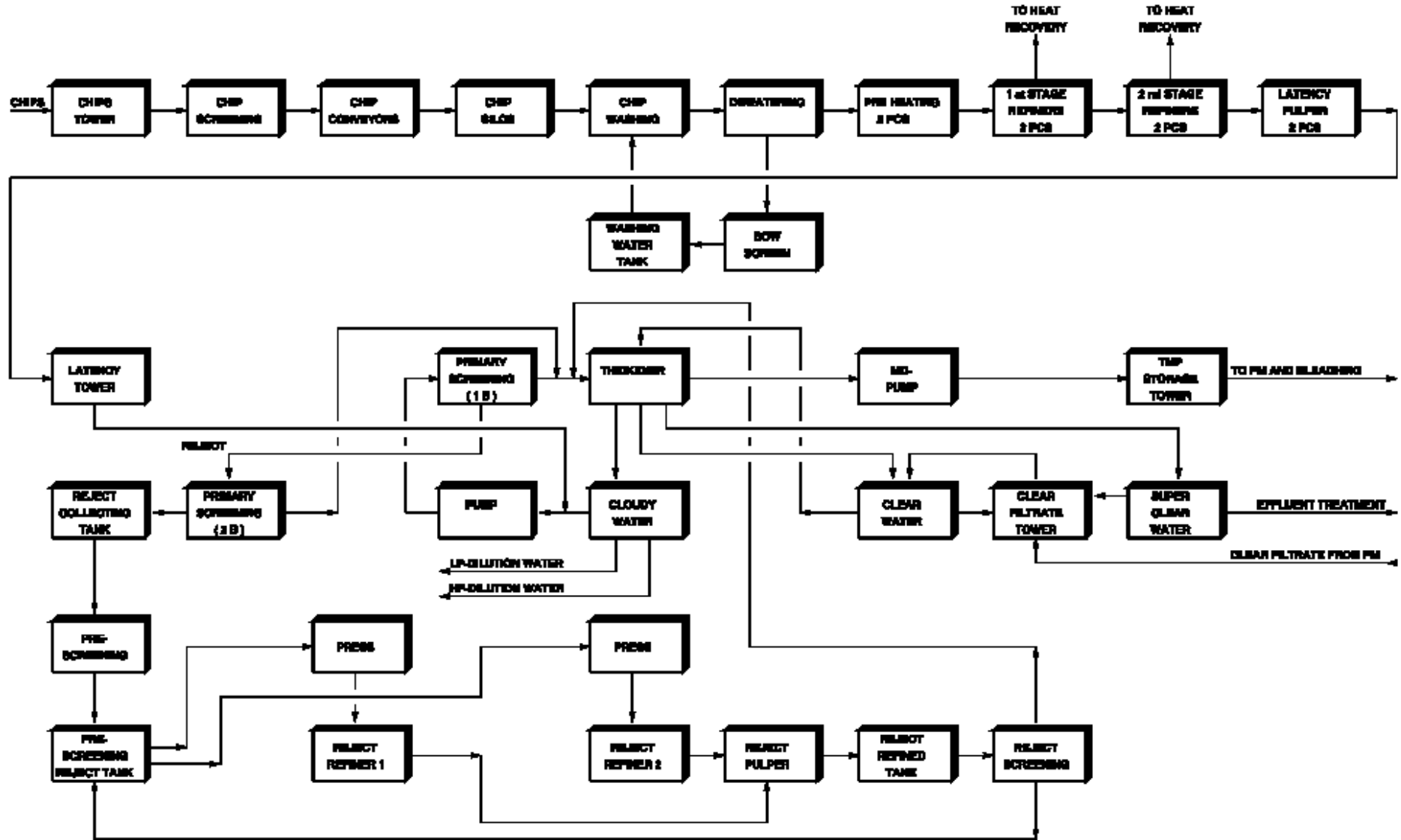

# 新聞紙TMP線流程圖

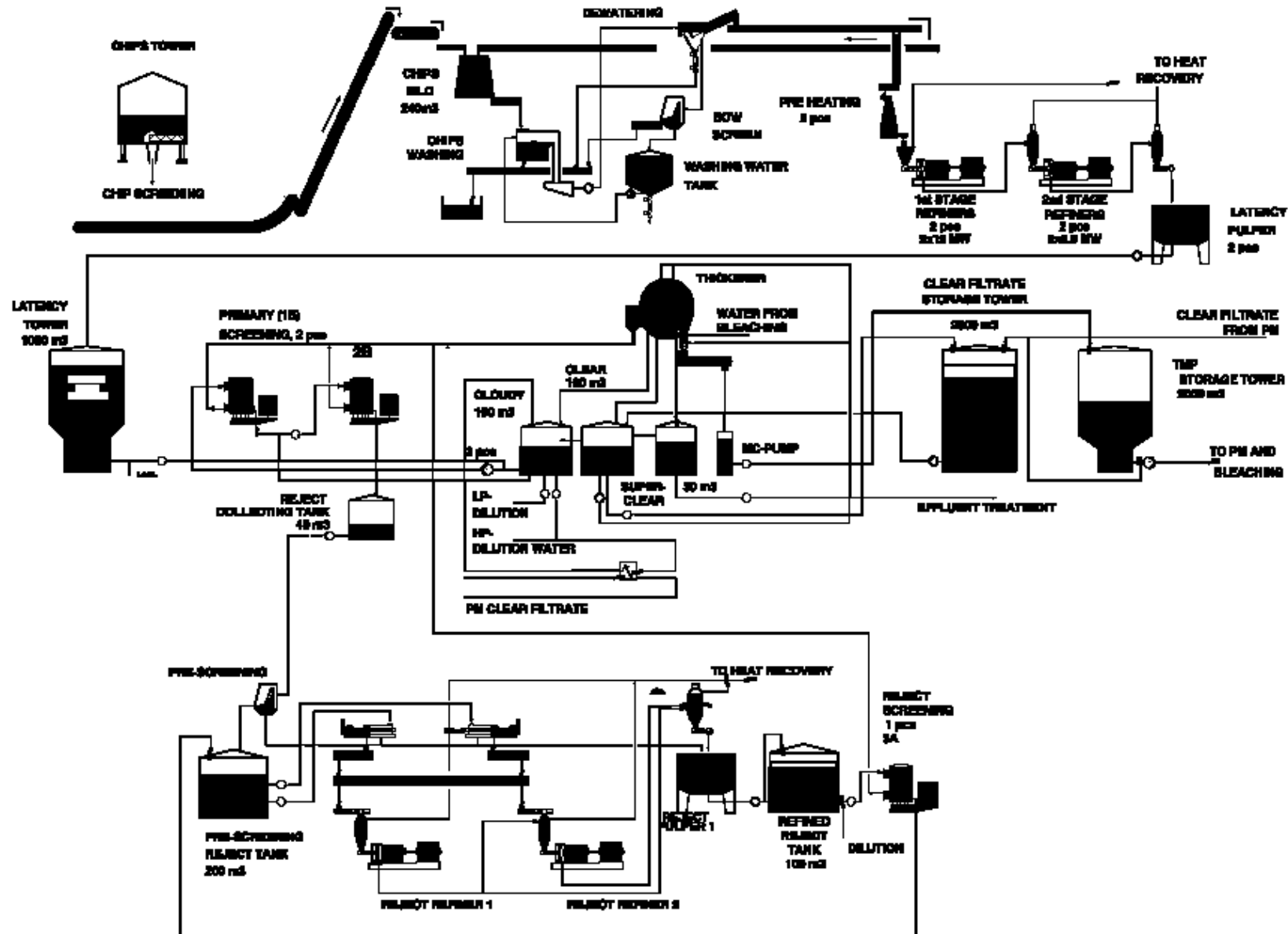

# 新聞紙DIP線方塊圖

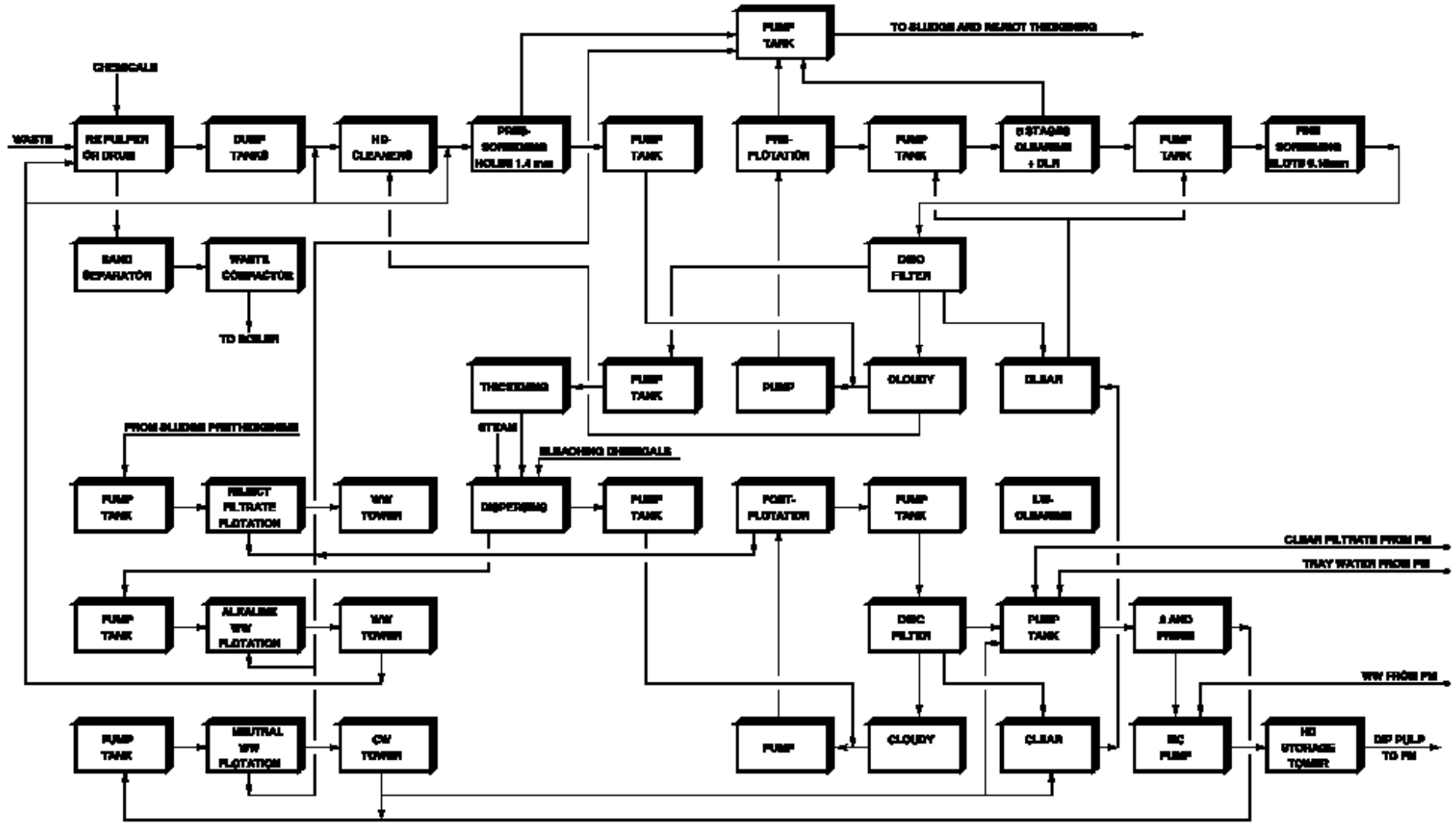

# 新聞紙DIP線流程圖

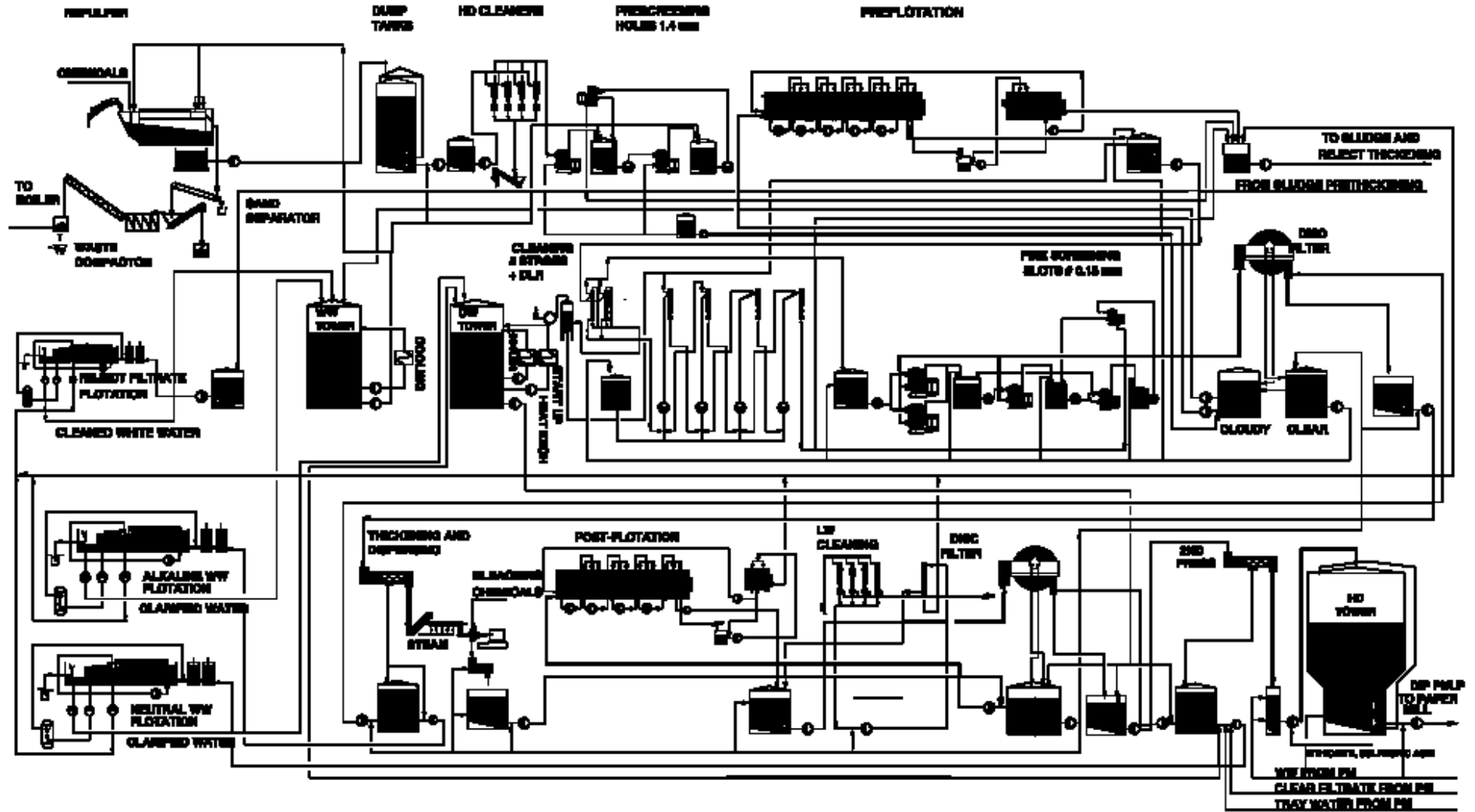



# 新聞紙抄紙機方塊圖

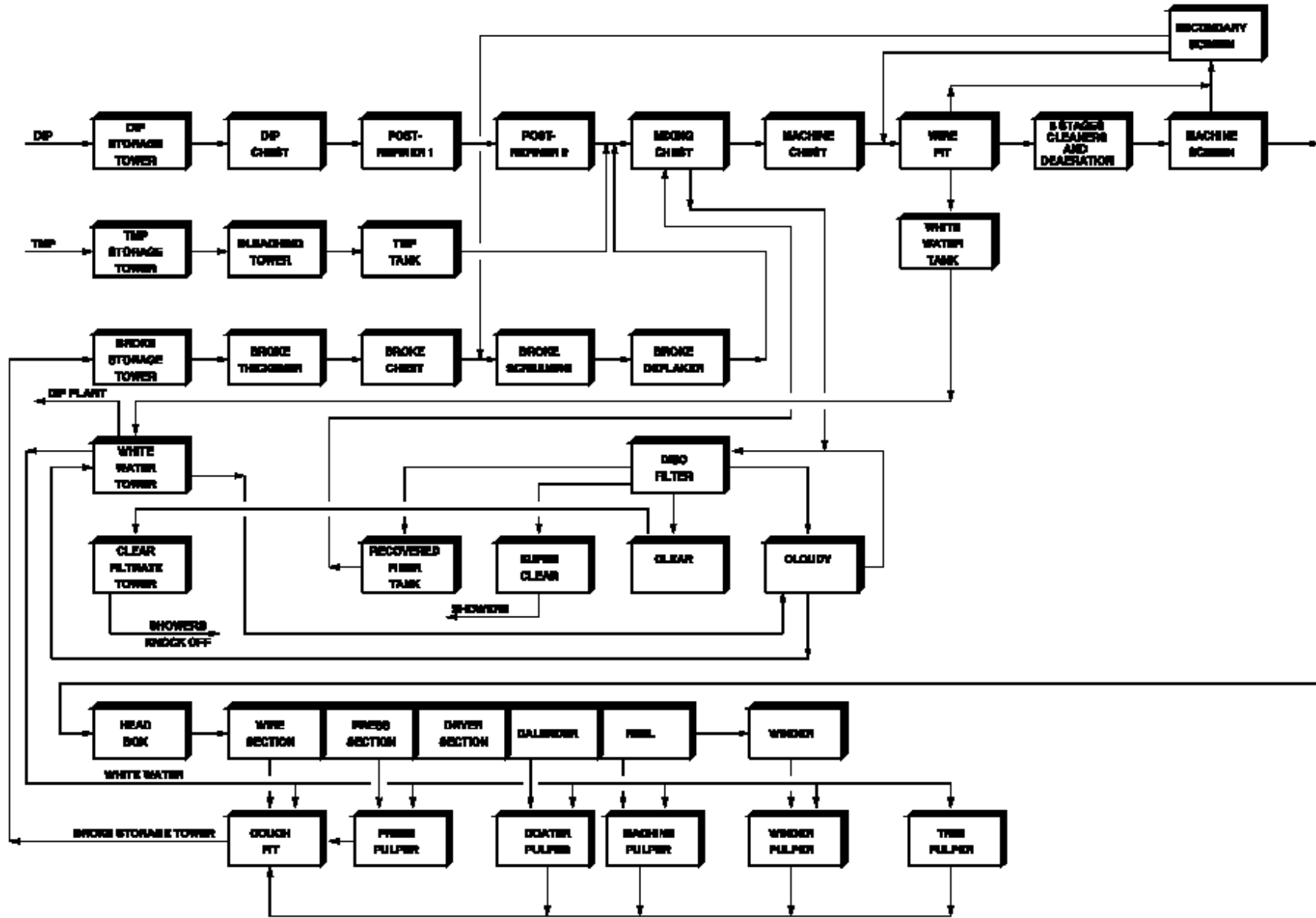

# 新聞紙抄紙機流程圖

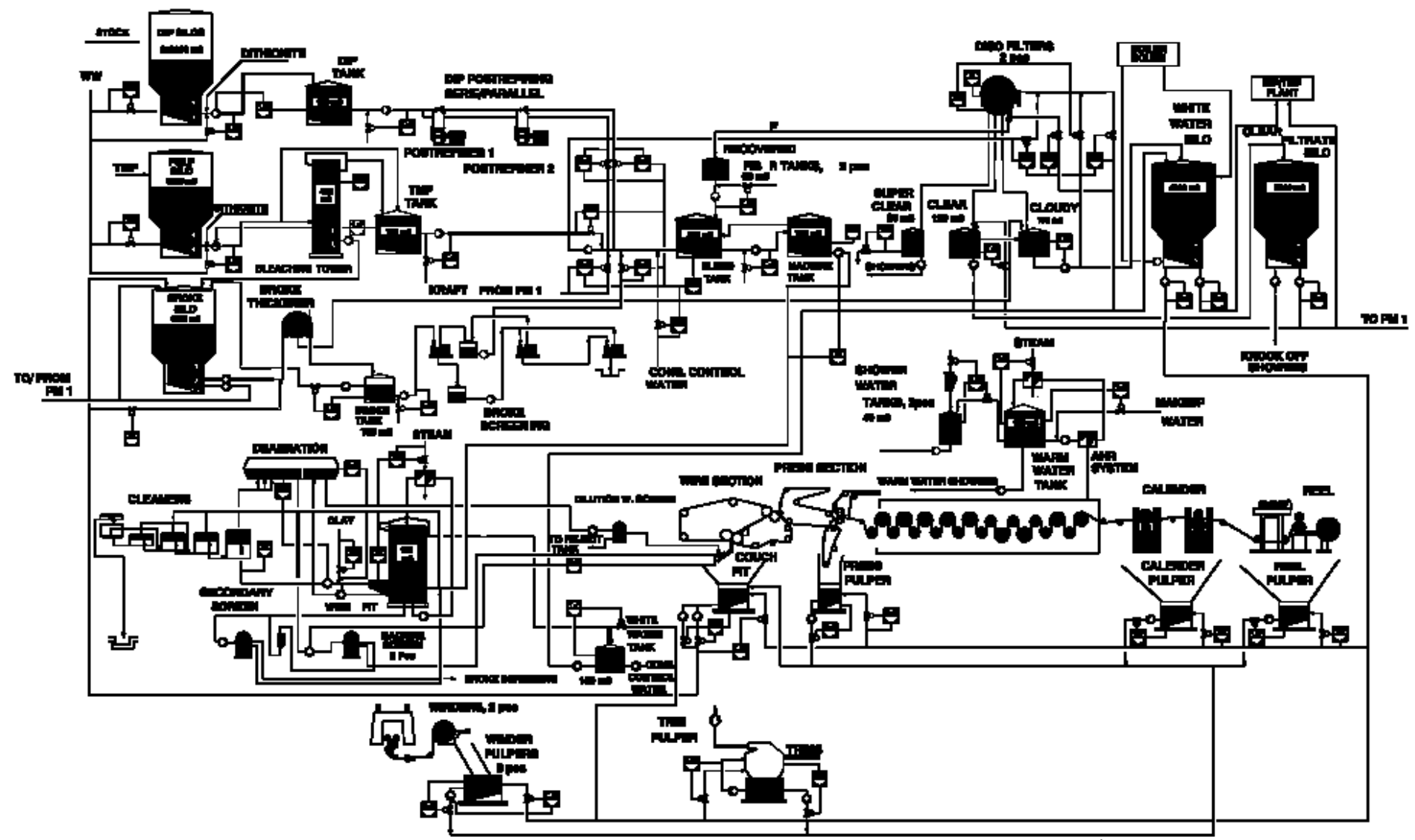

# 新聞紙抄紙機示意圖

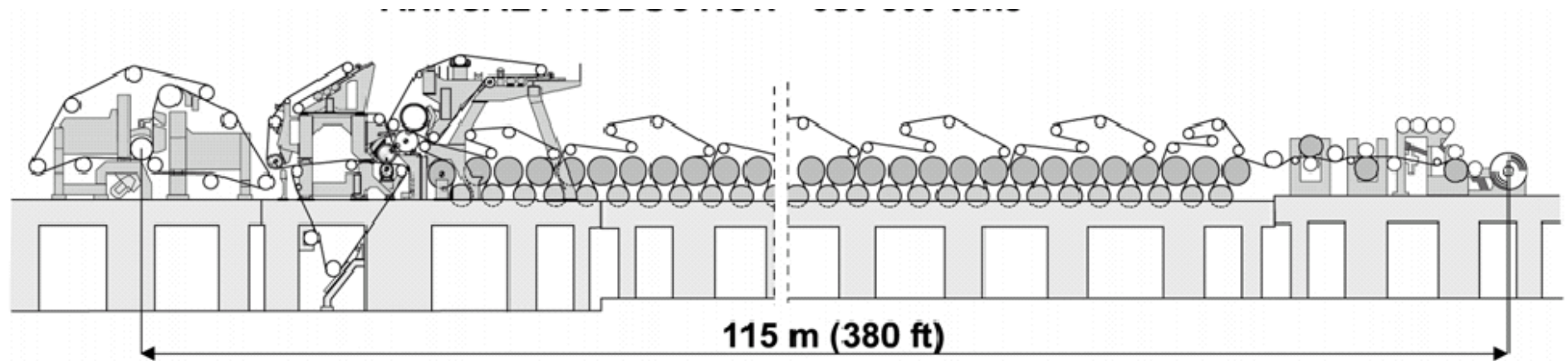

# LWC廠

TMP/PGW

PM line  
incl. coater

Finishing

Coating color  
kitchen

# TMP與LWC一貫廠方塊圖

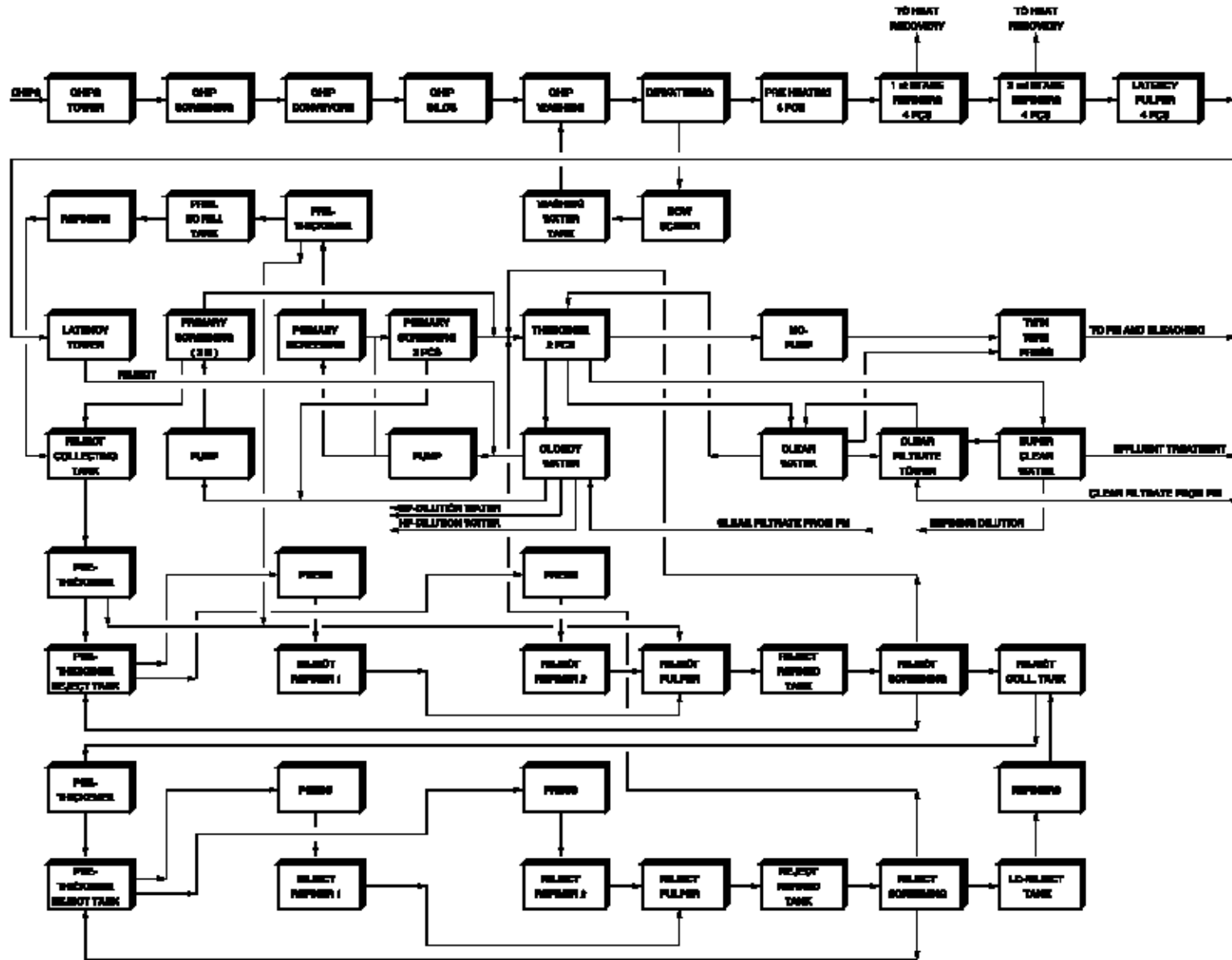

# TMP與LWC一貫廠流程圖

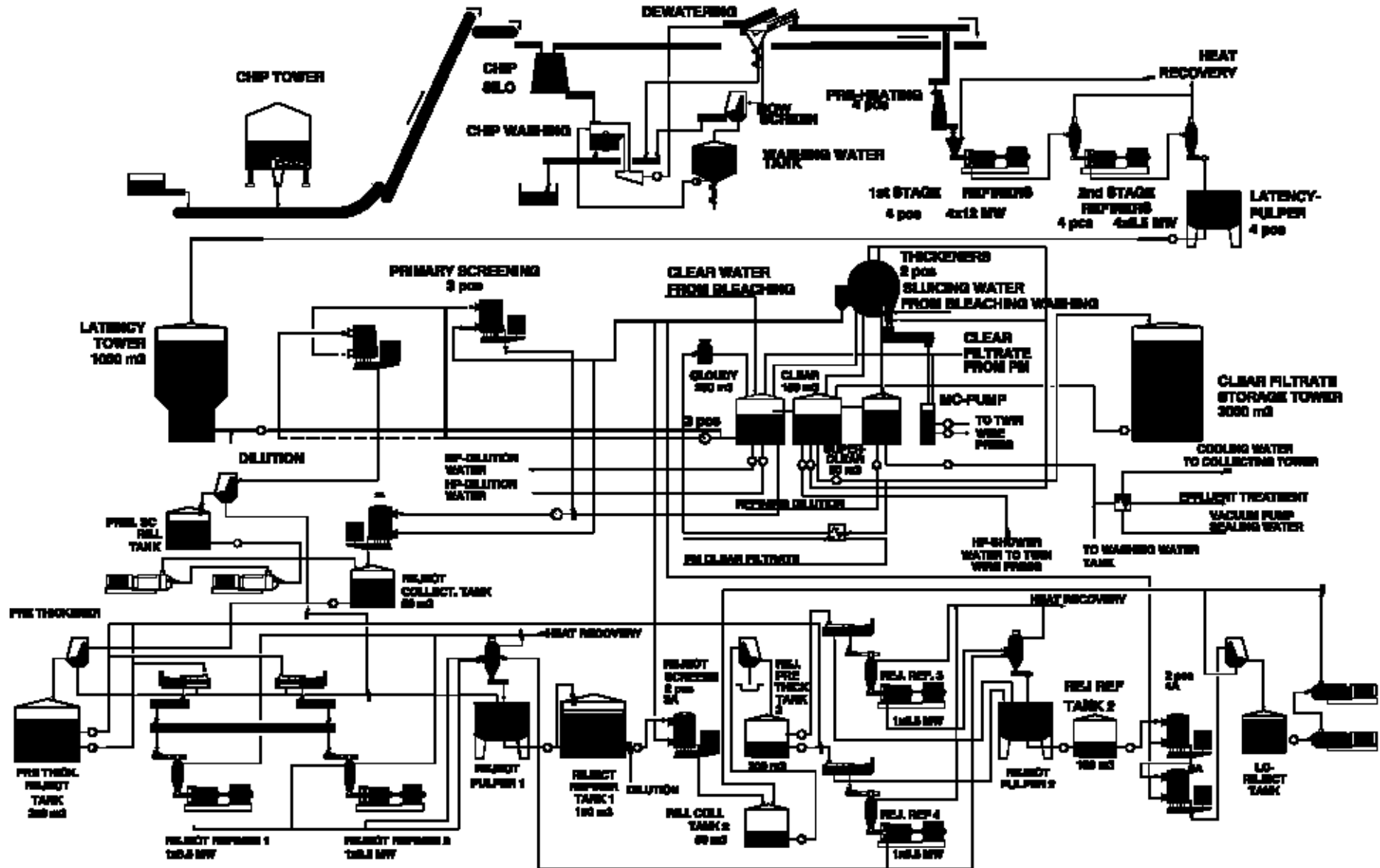

# PGW與LWC一貫廠方塊圖

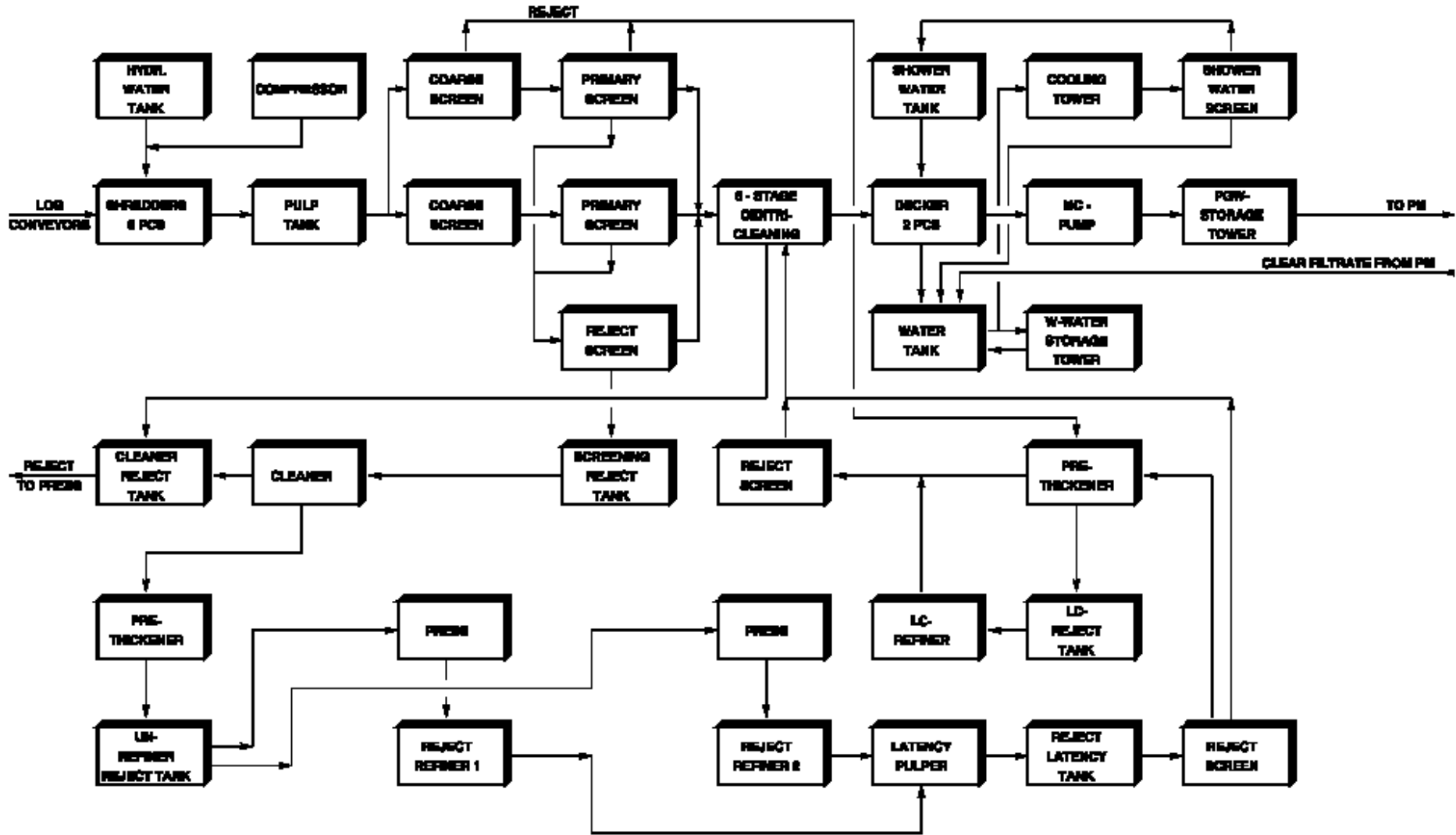

# PGW與LWC一貫廠流程圖

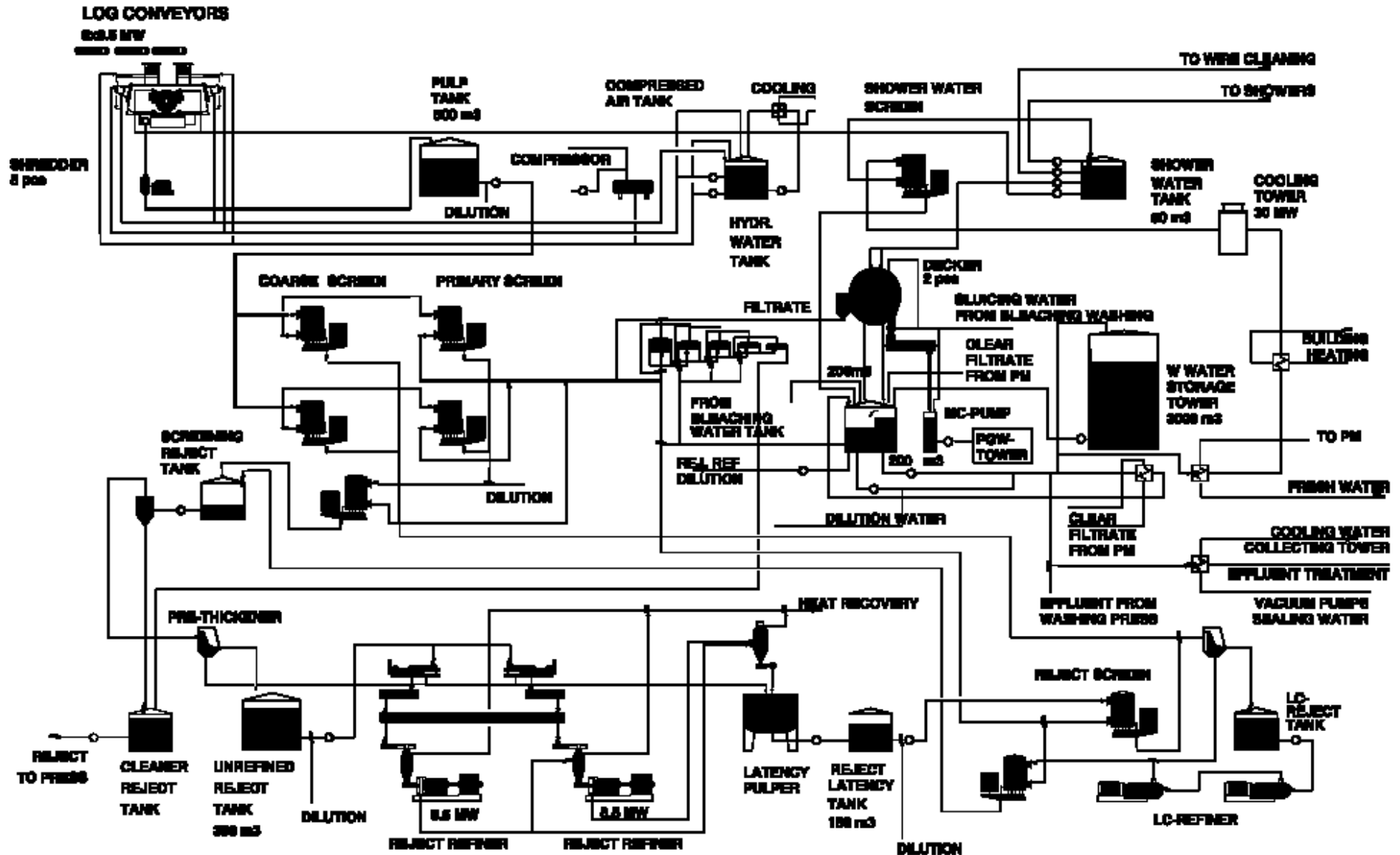



# 塗料配製方塊圖

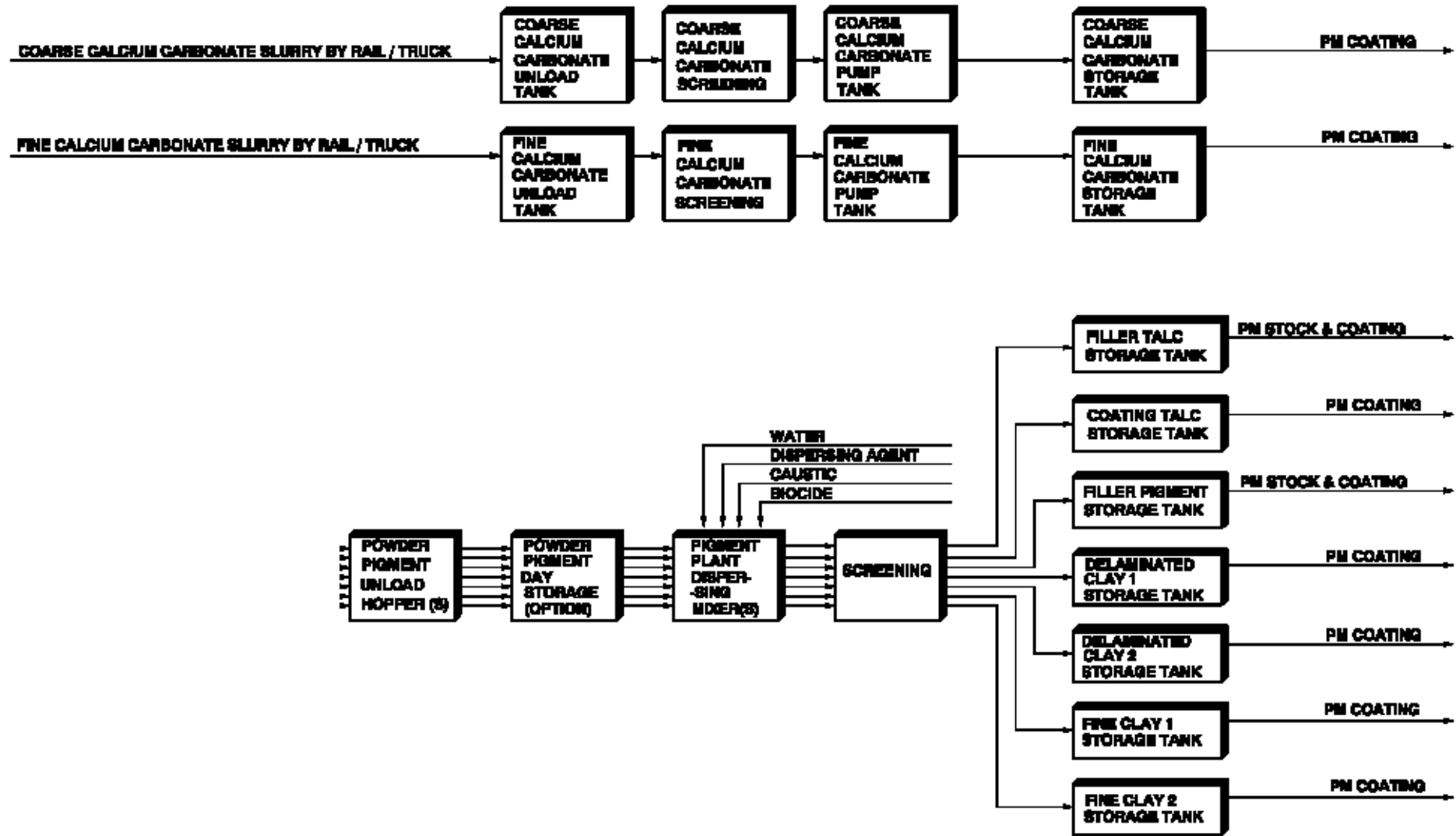

# 塗料配製室方塊圖

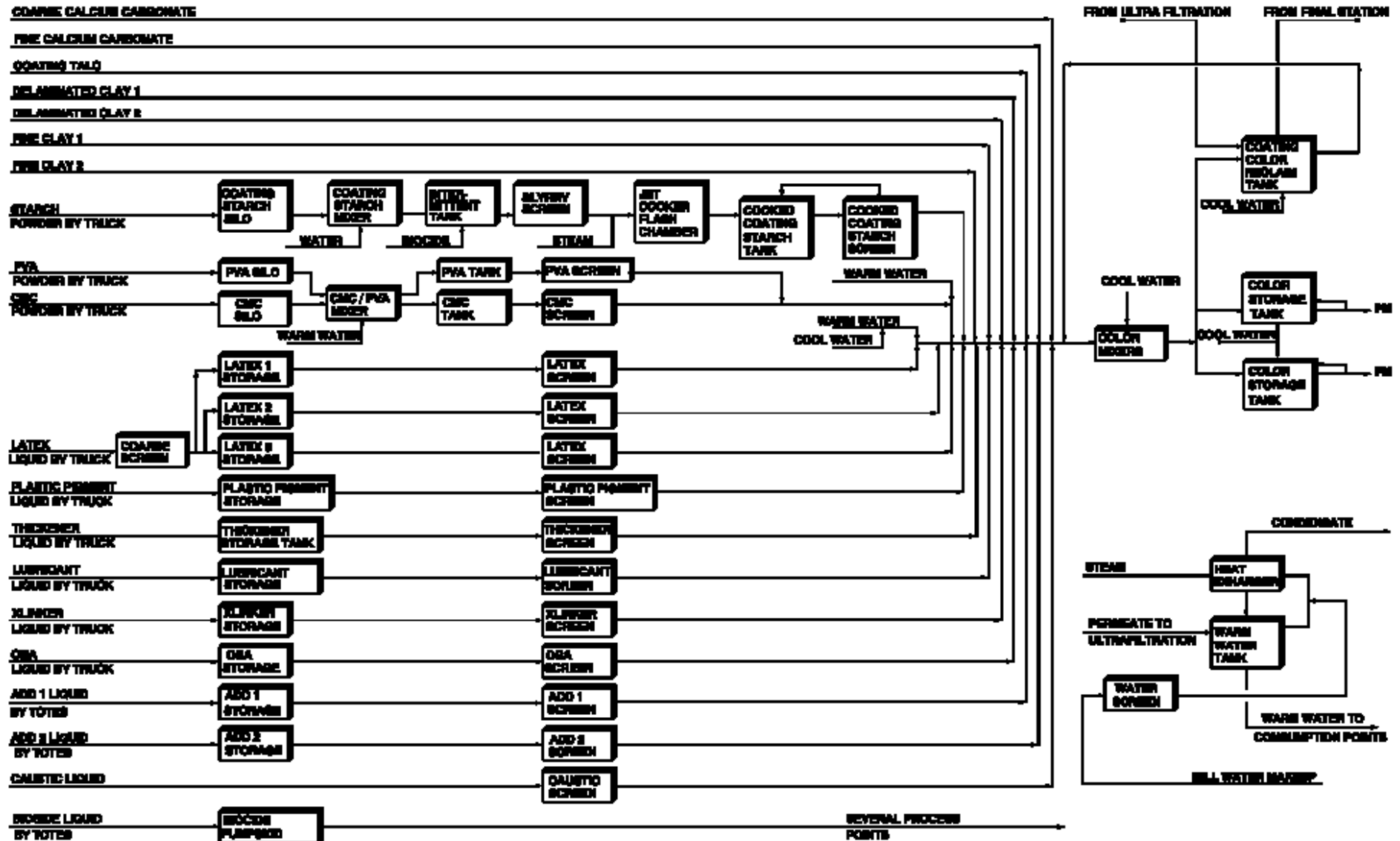

# LWC抄紙機方塊圖

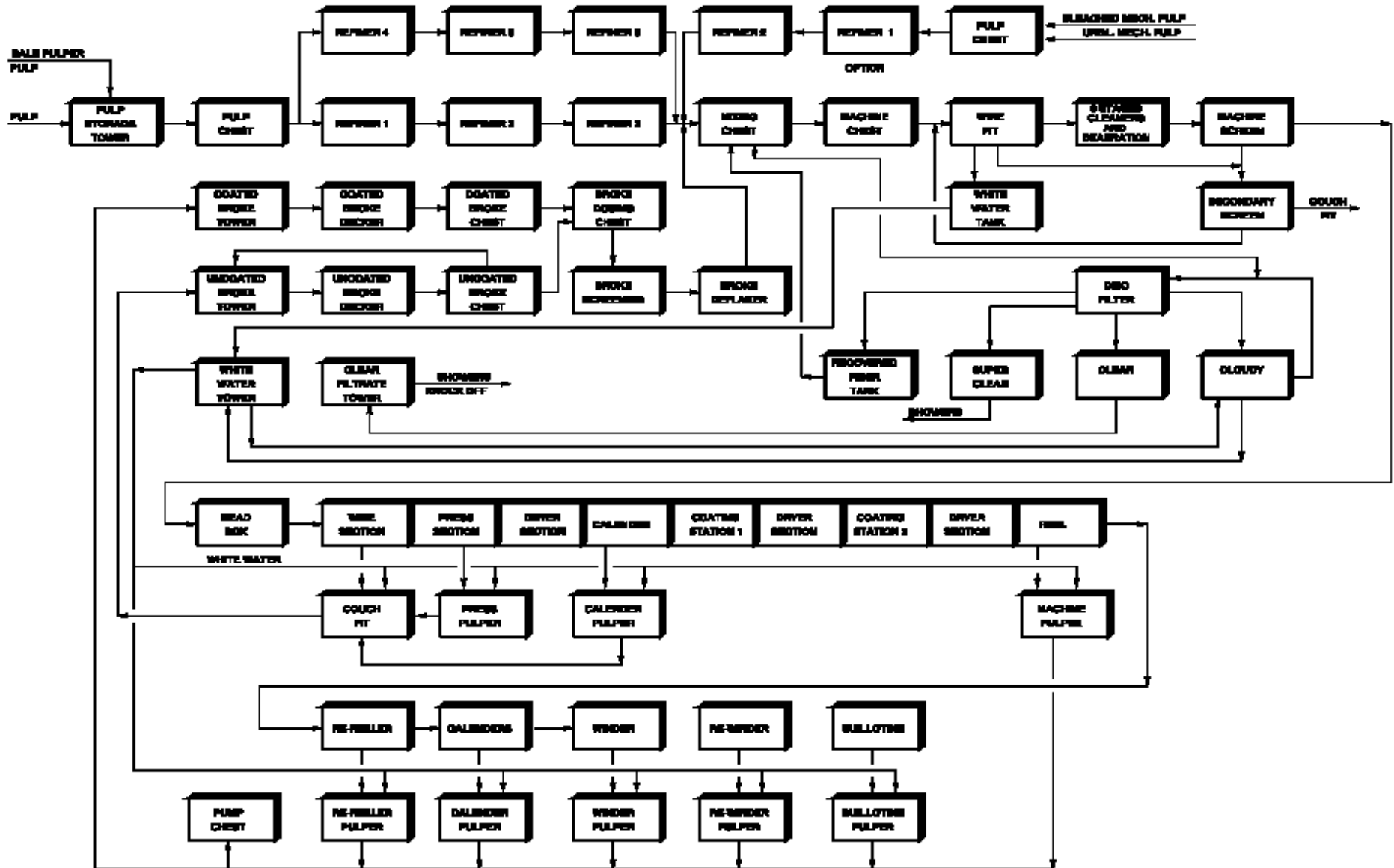

# LWC抄紙機流程圖

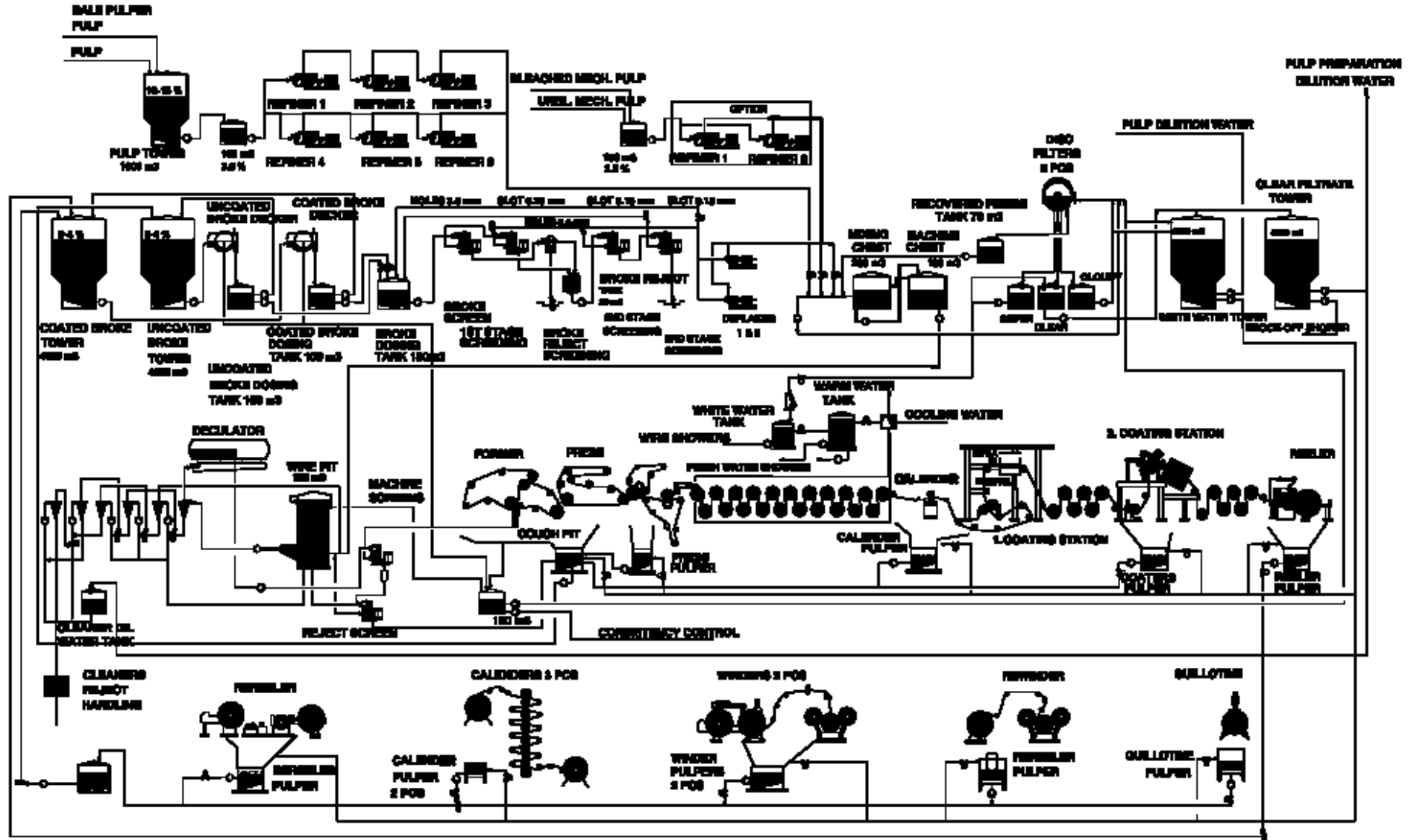

# LWC抄紙機示意圖

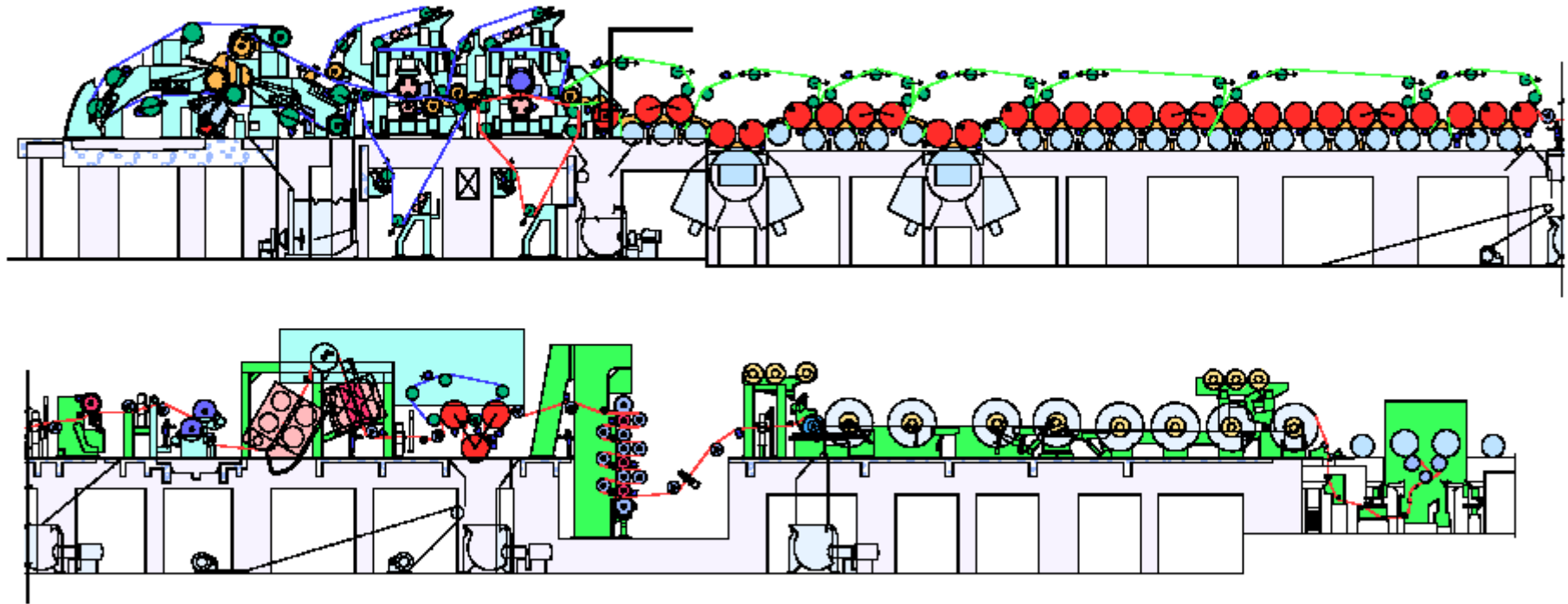

# 未塗佈文化用紙廠

PM line

Sheeting and  
packaging

# 文化用紙廠方塊圖

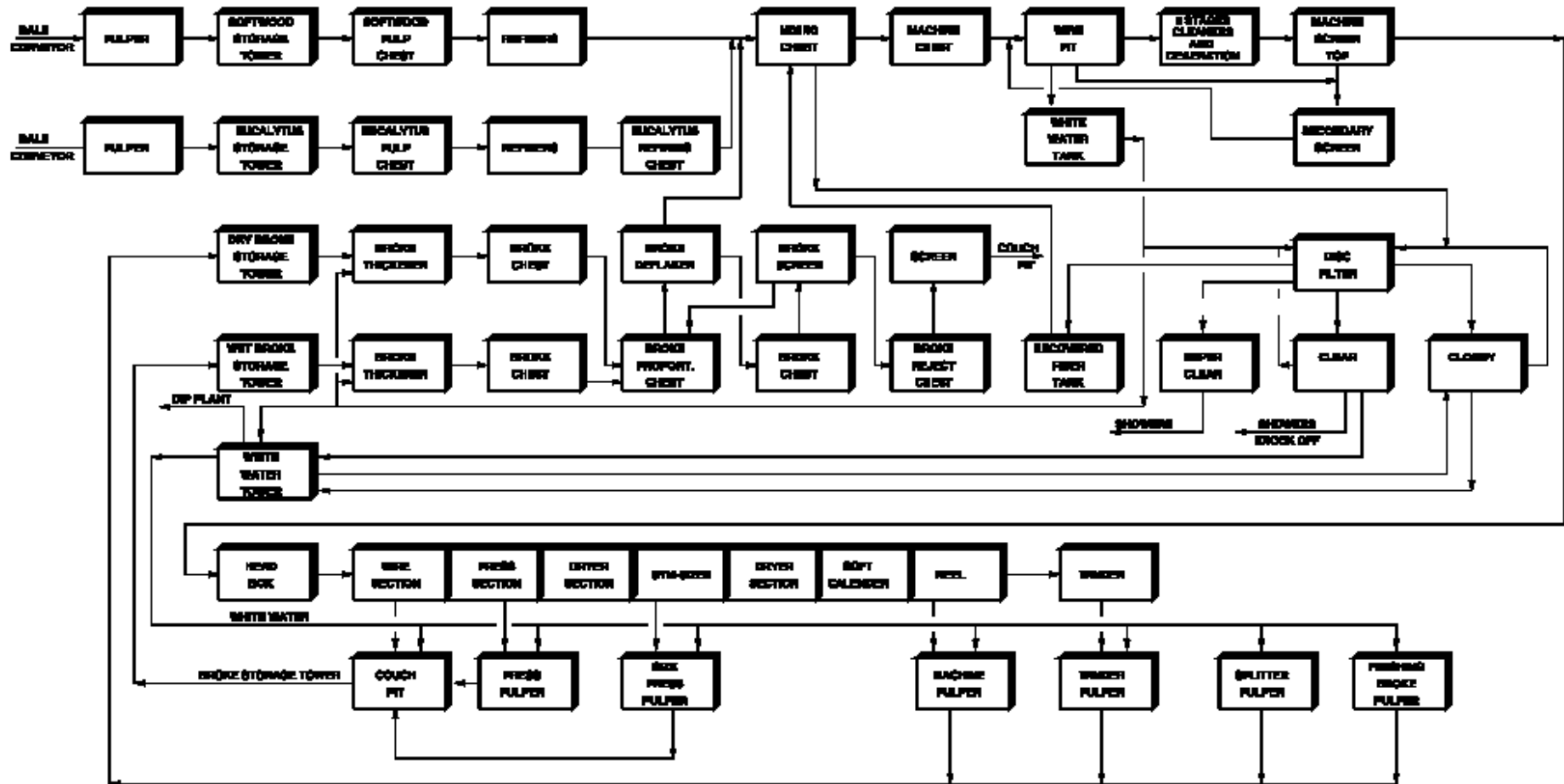

# 文化用紙廠流程圖

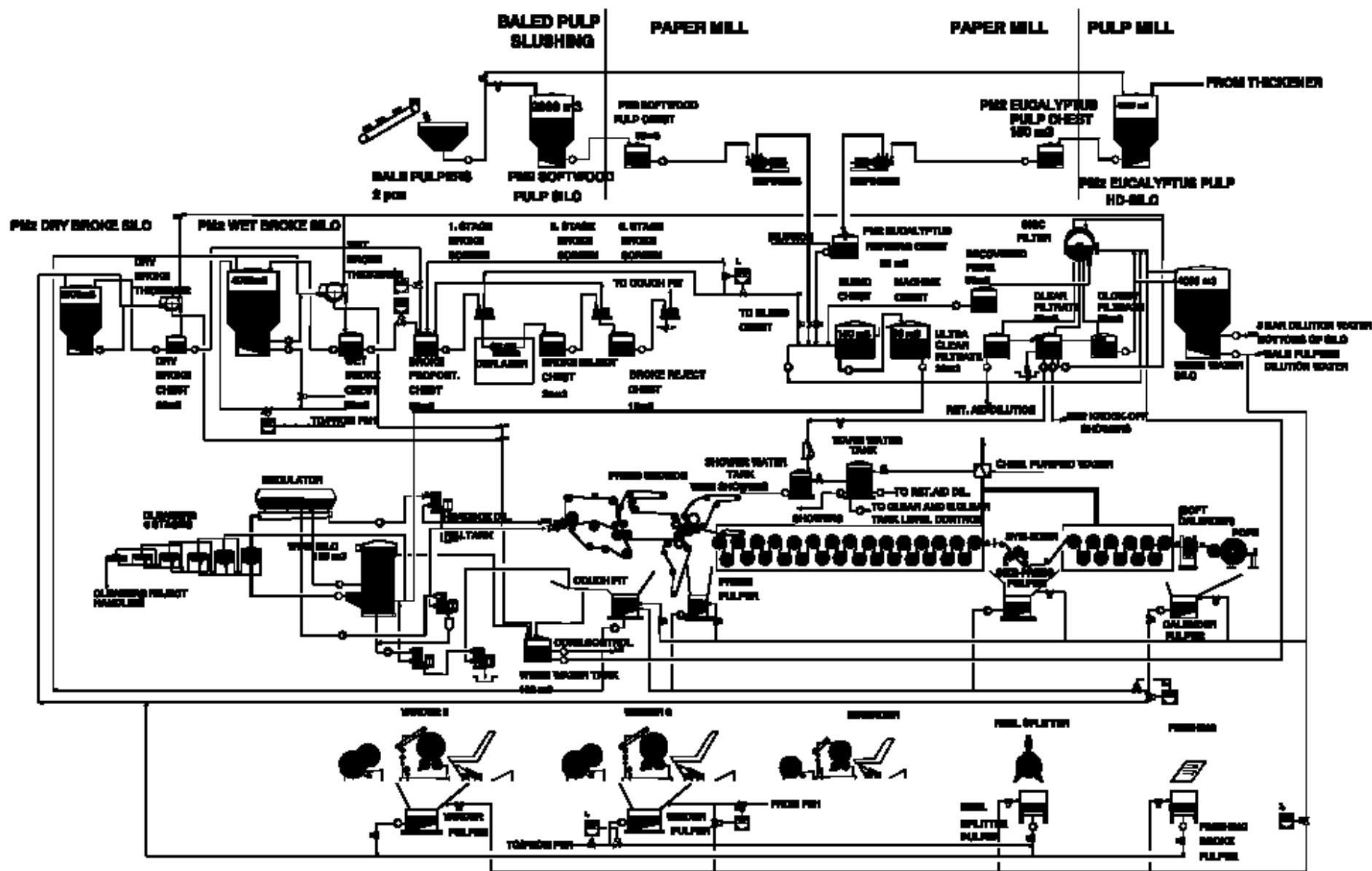



# 文化用紙廠抄紙機示意圖

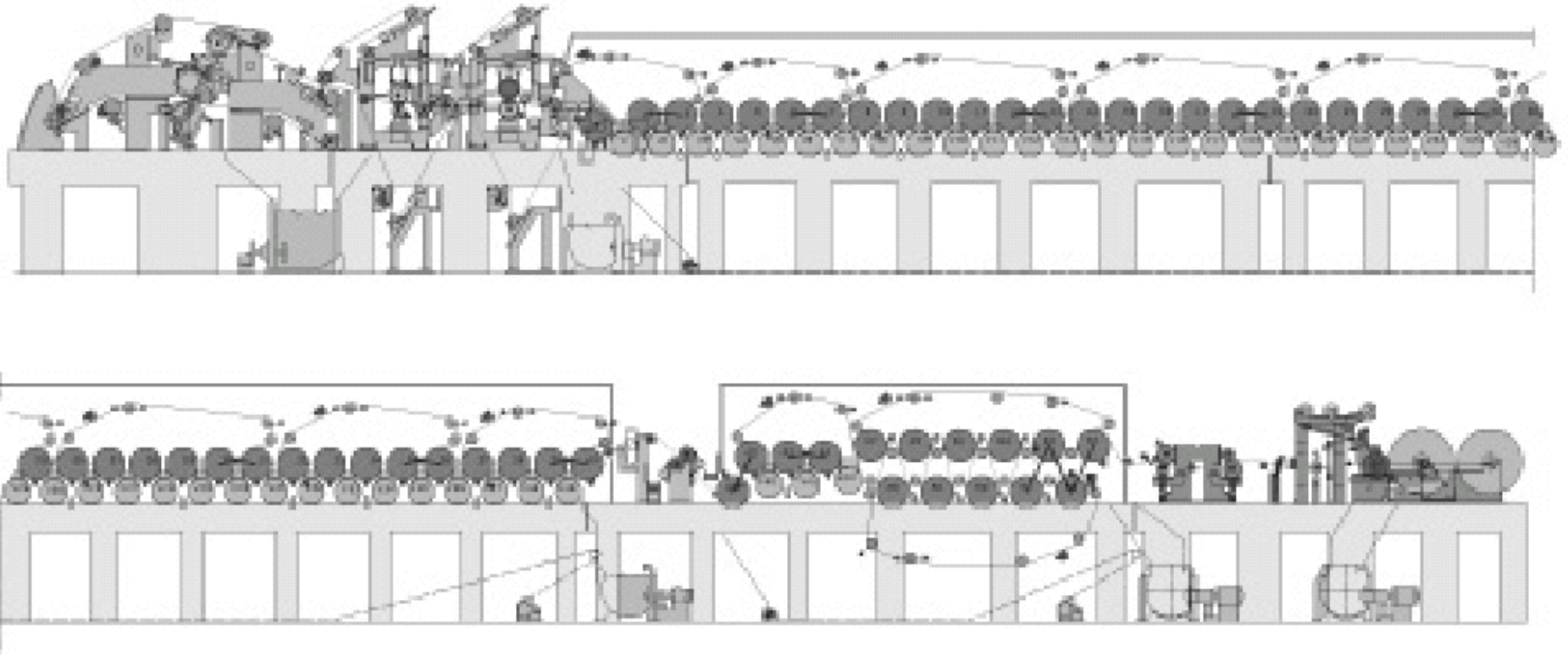

# 裱面紙板

Recycled fiber  
plant

PM line

Packaging

# 廢紙製漿線方塊圖

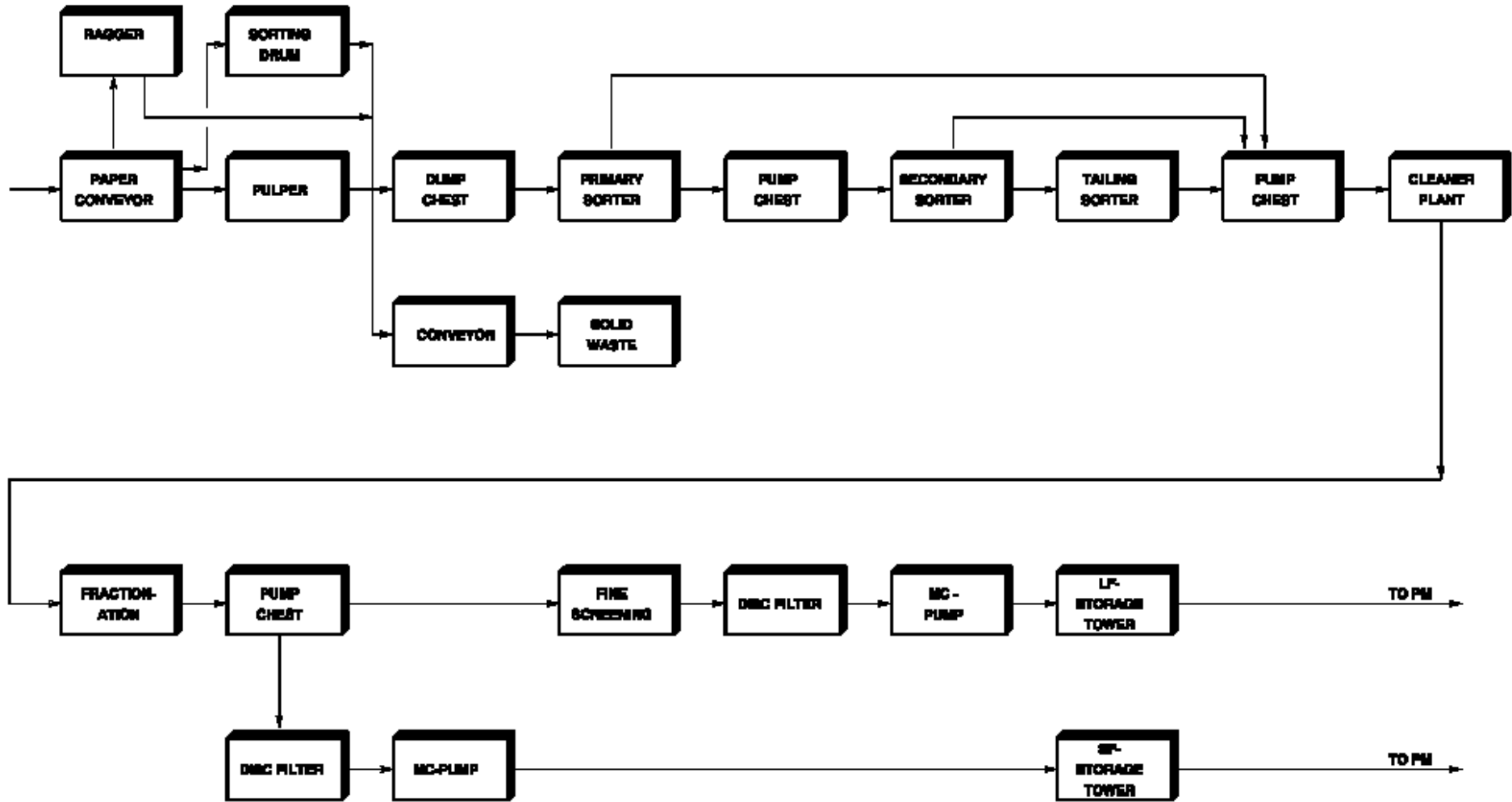

# 廢紙製漿線流程圖

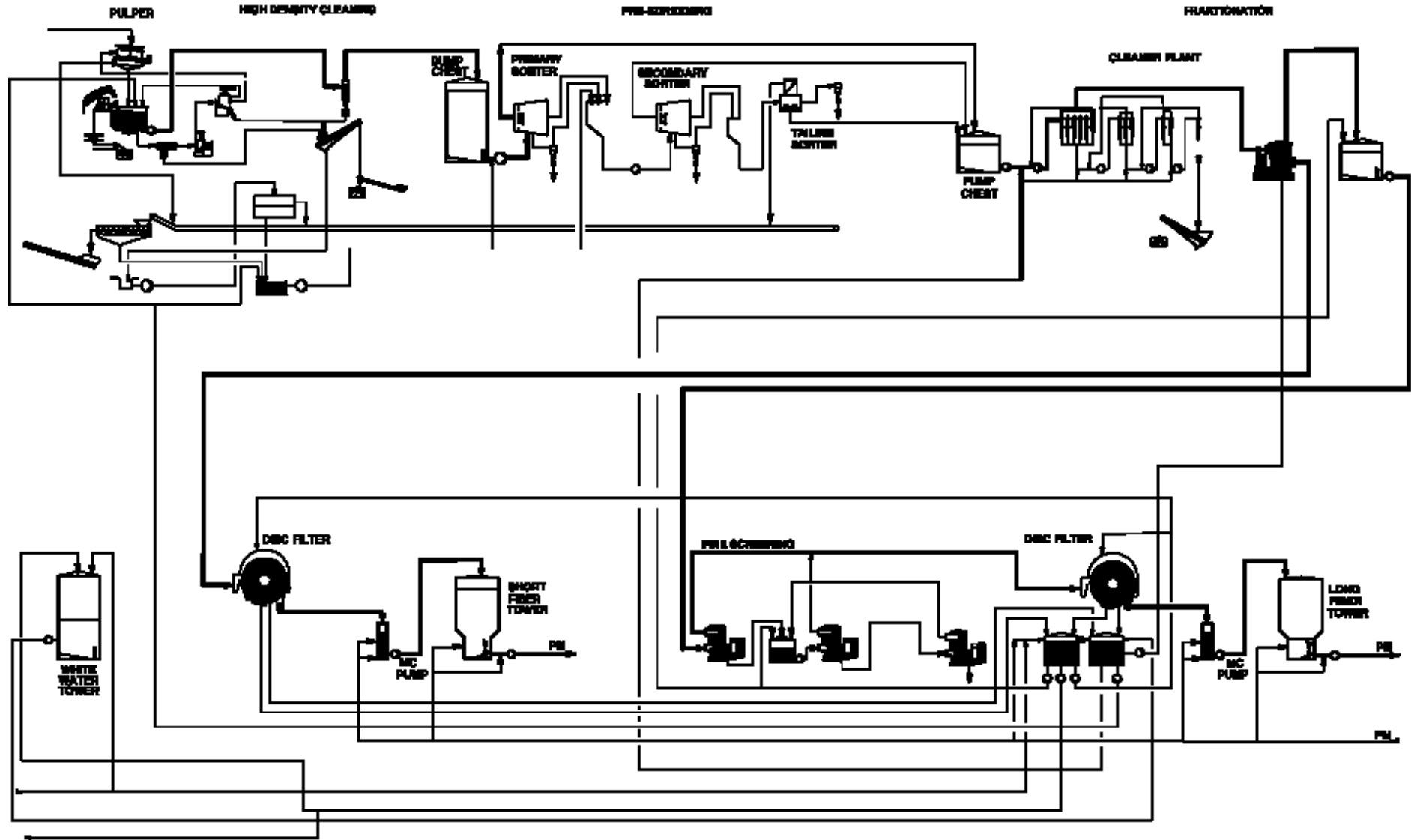

# 裱面紙板抄紙機方塊圖

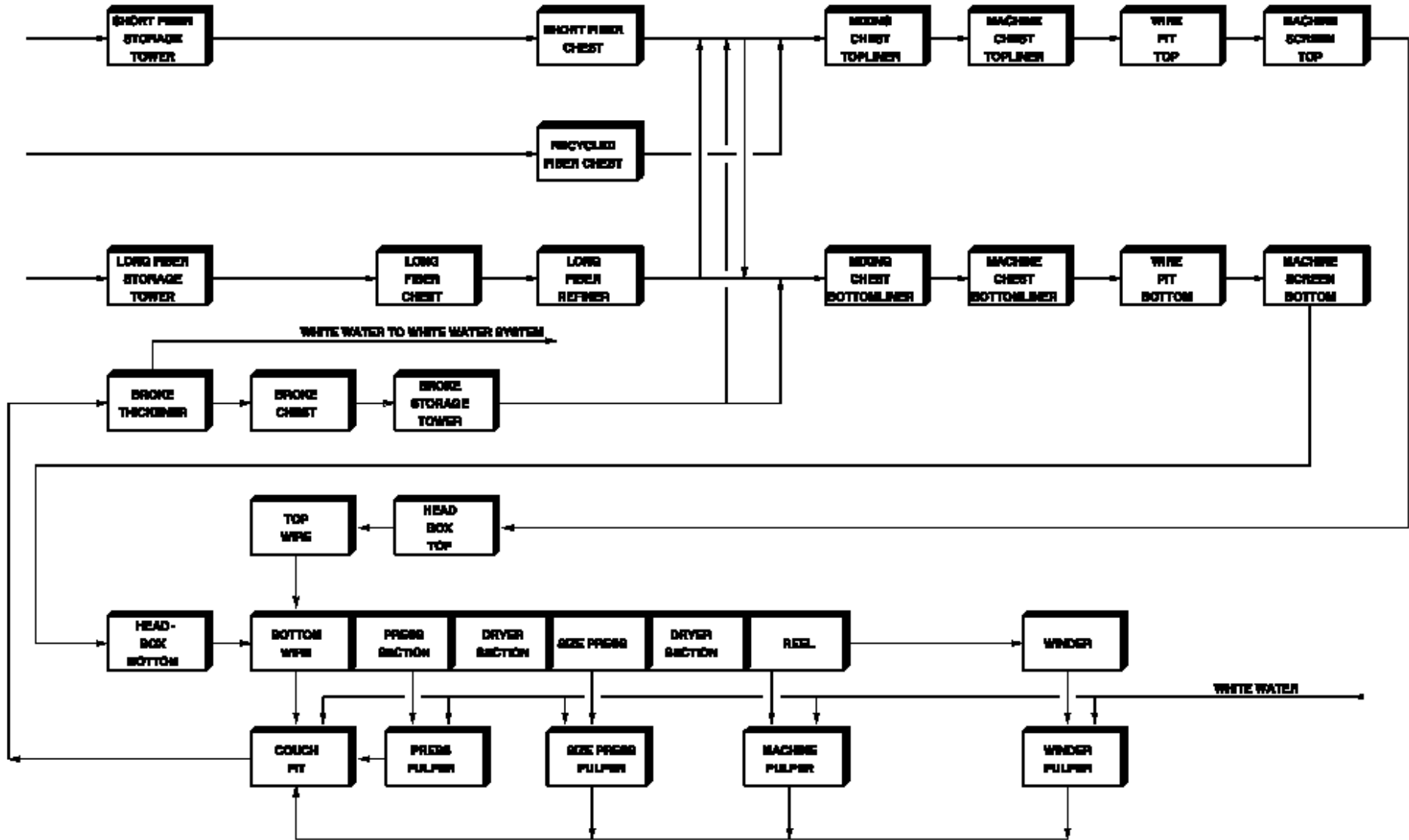

# 裱面紙板抄紙機流程圖

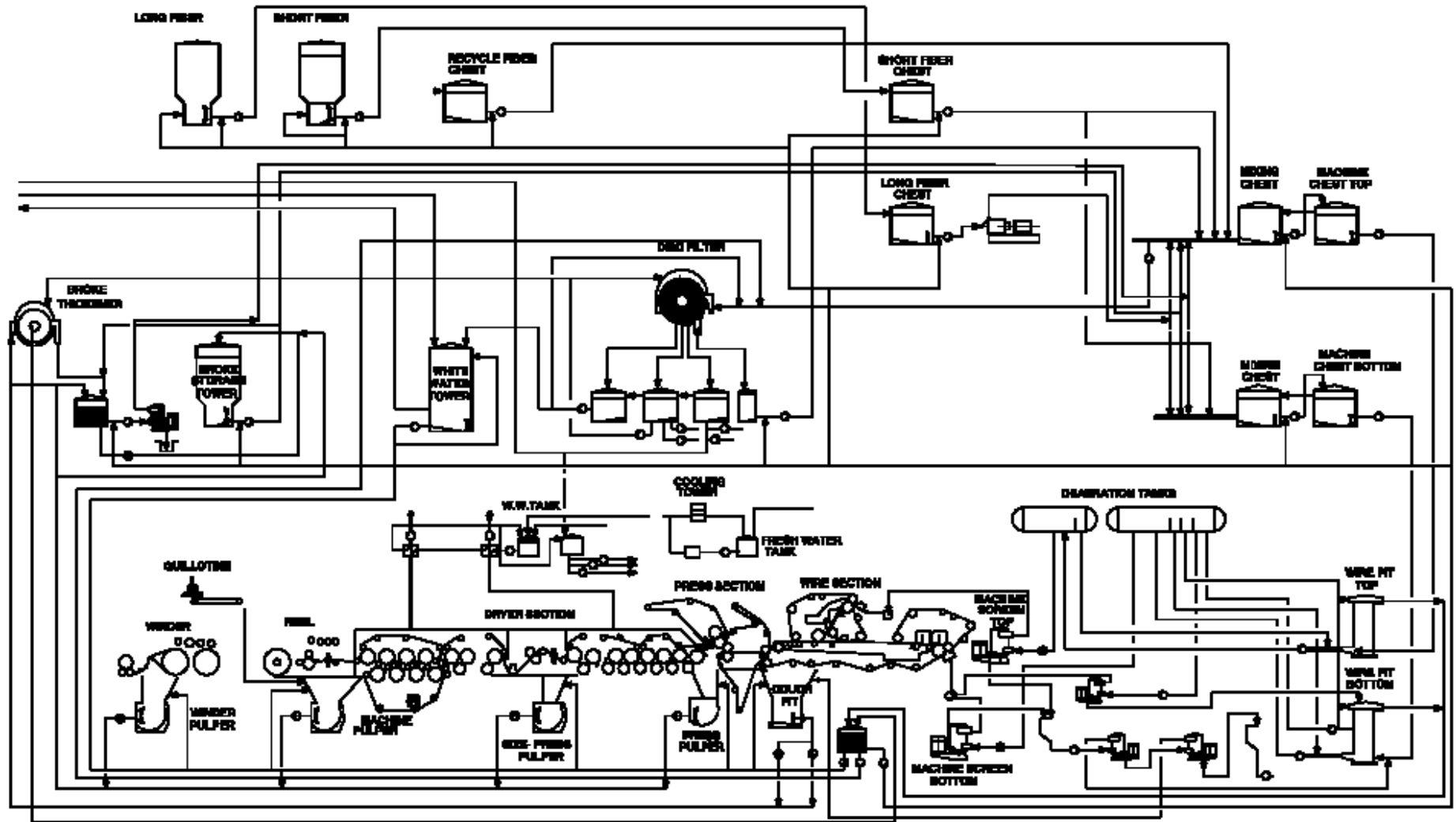

# 裱面紙板抄紙機示意圖

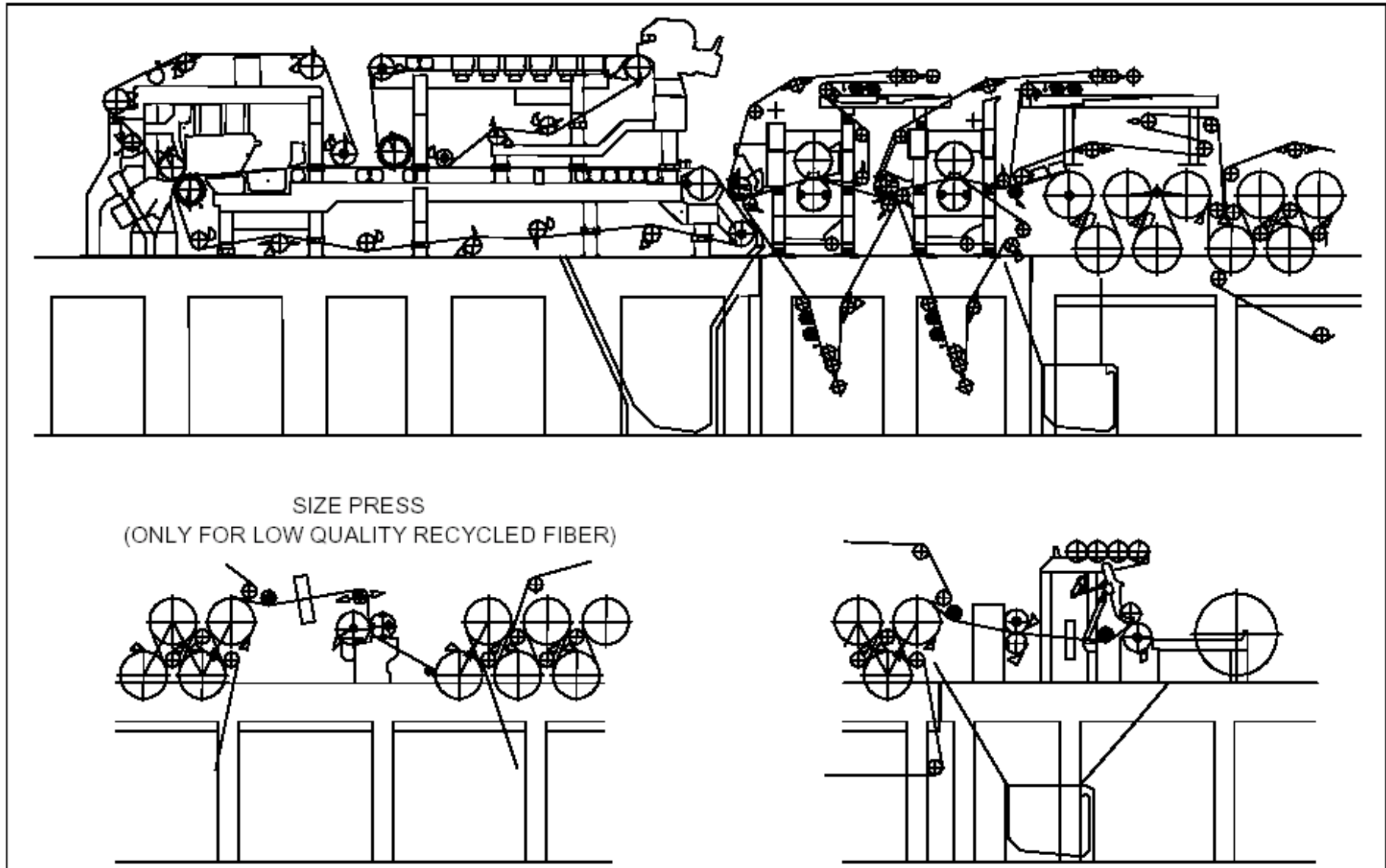

# 多層紙板廠

TMP/PGW

Board line

Sheet cutting  
packaging

or/and

Recycled fiber  
plant

Board line

Sheet cutting  
packaging



# 多層紙板線方塊圖

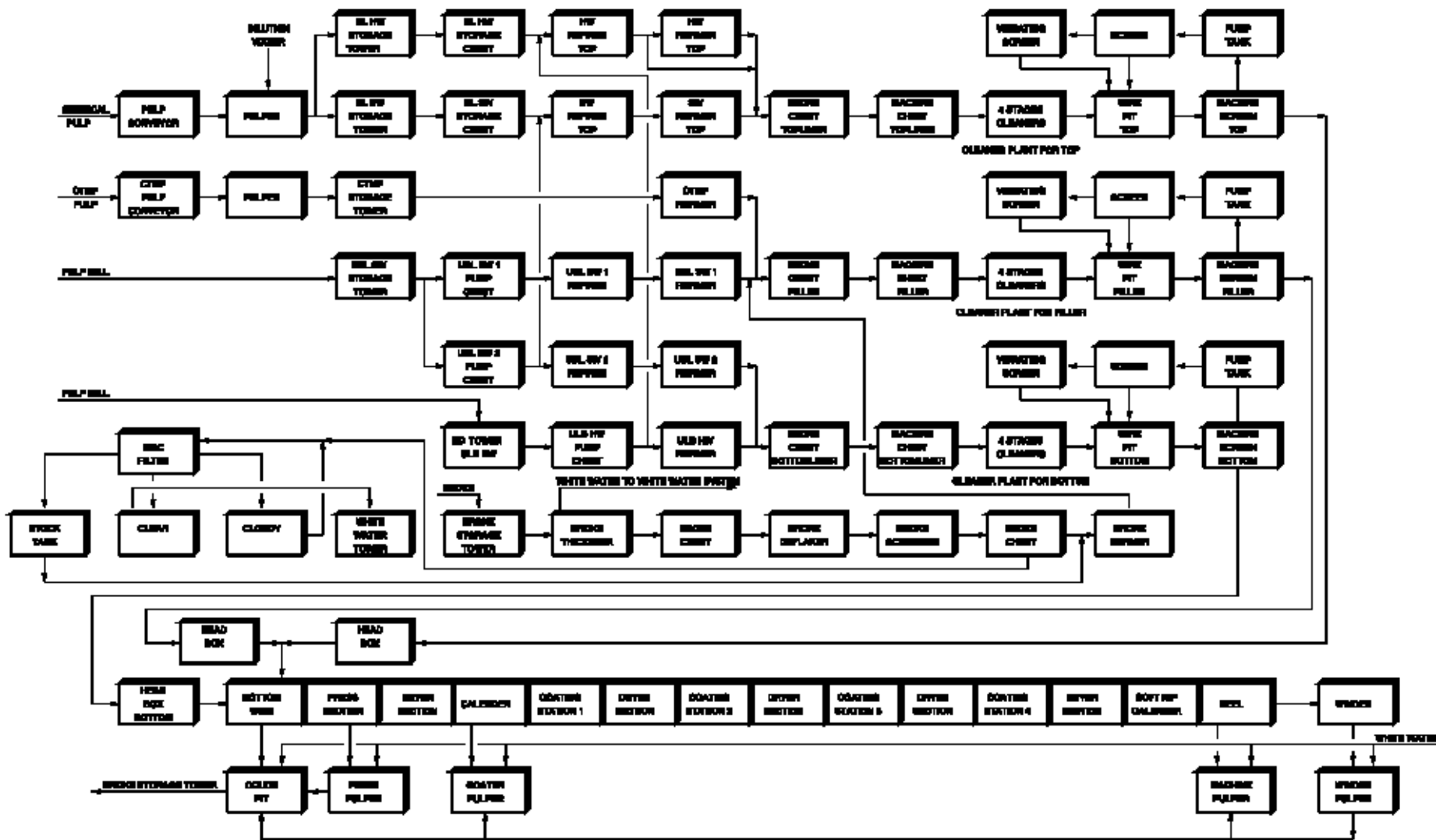

# 多層紙板線流程圖

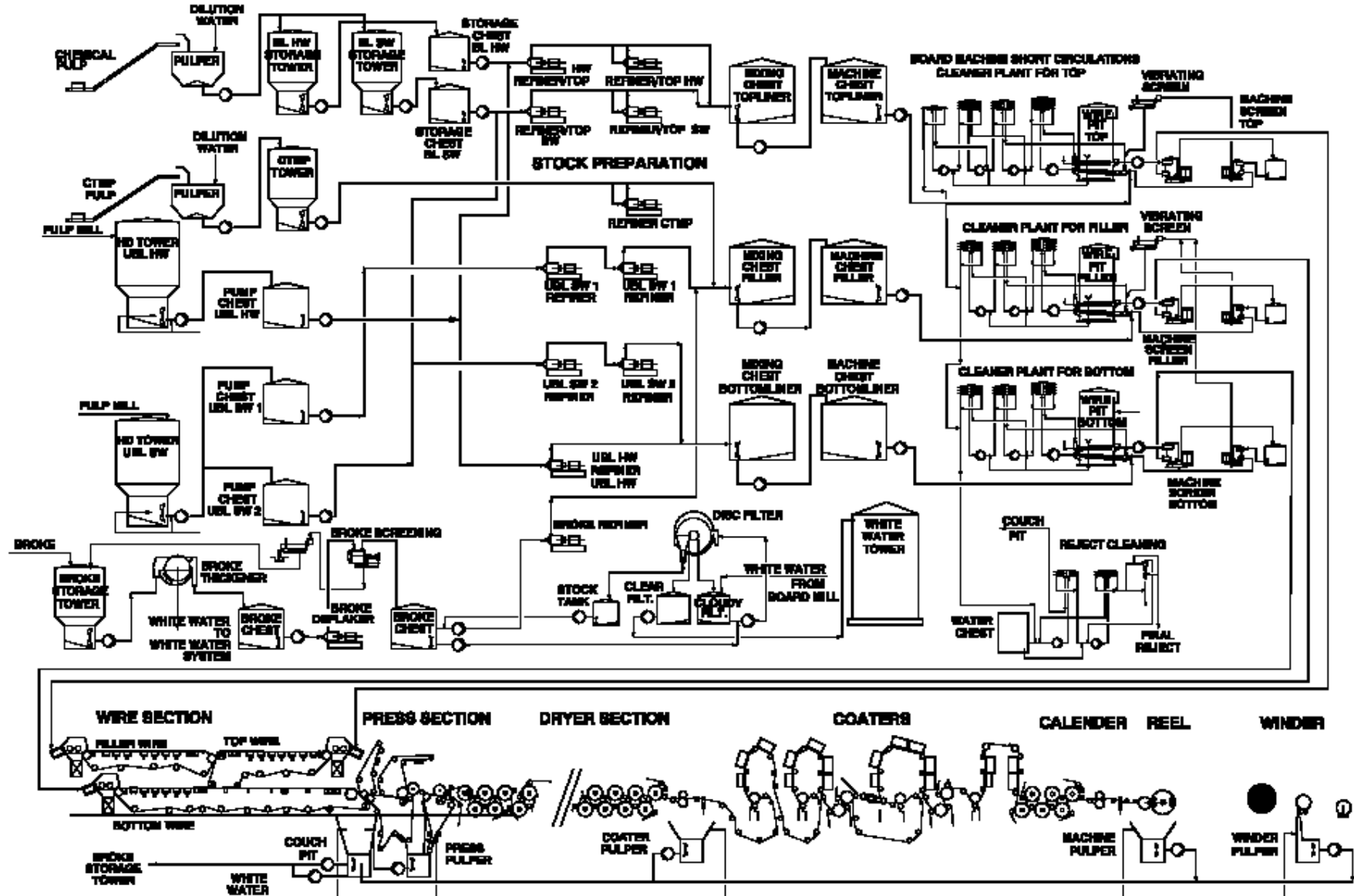

# 多層紙板抄紙機示意圖

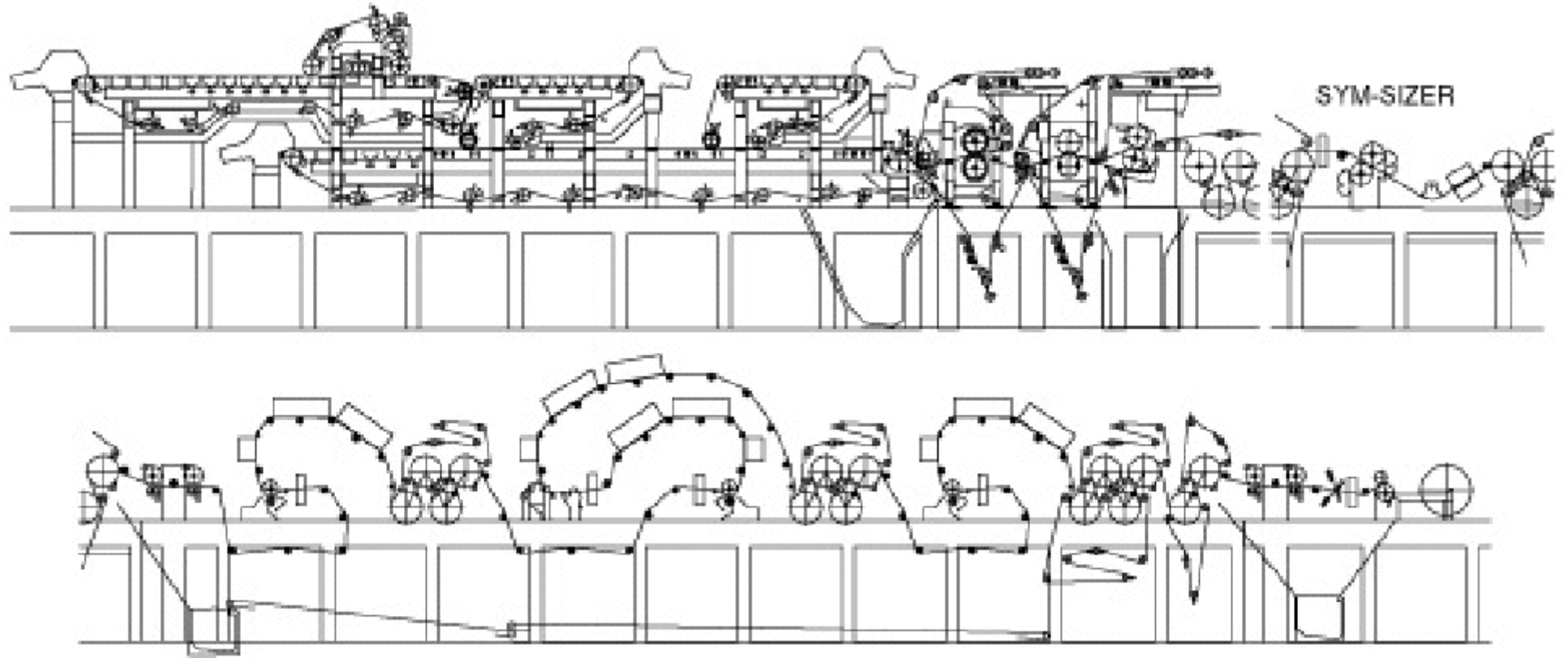

# 家庭用紙廠



PM line



Converting

# 家庭用紙線方塊圖

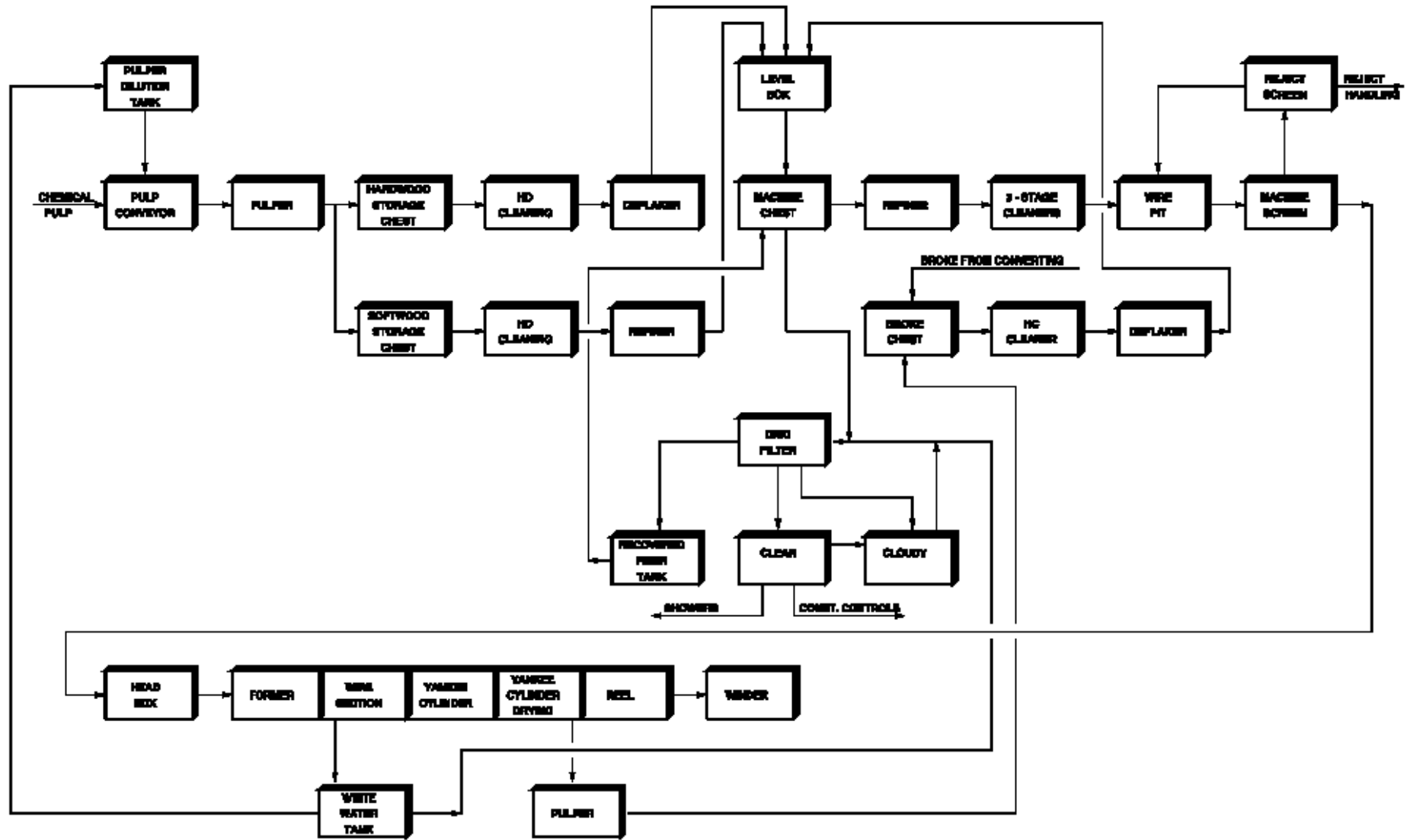

# 家庭用紙線流程圖

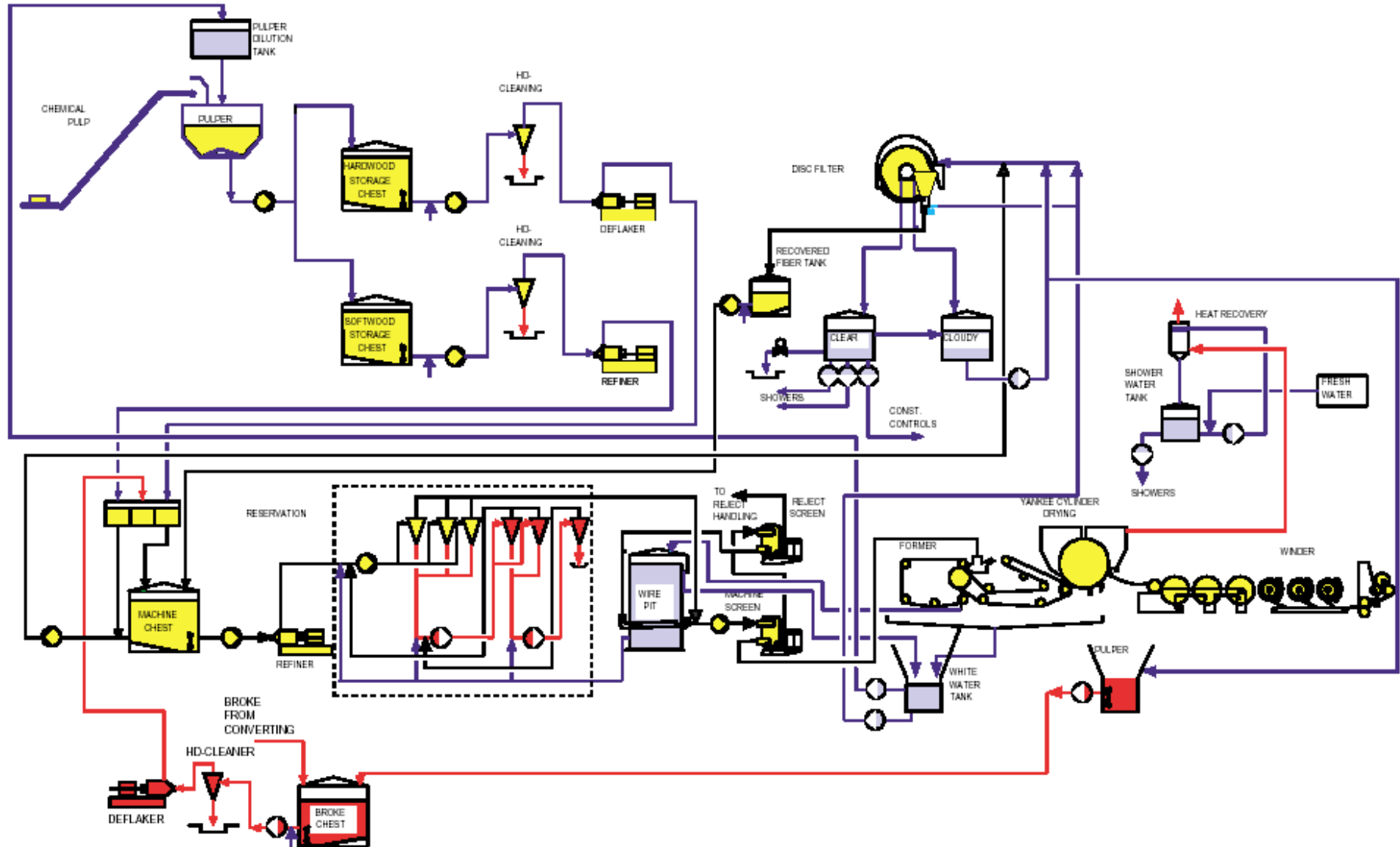

# 家庭用紙抄紙機示意圖

